

COTEK

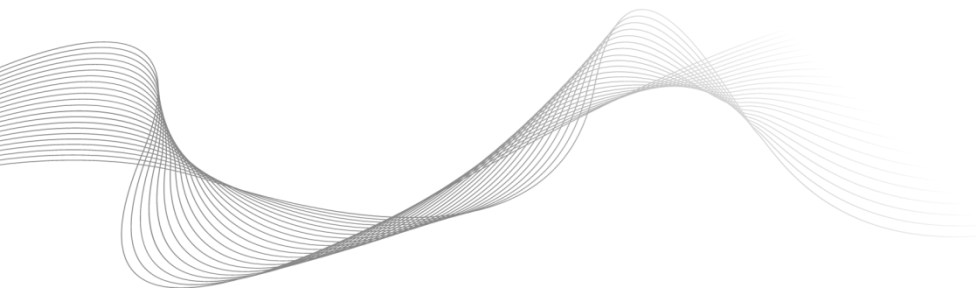

SP Series User's Manual

EN

[Page 3]

SP-700/1000/1500/2000/3000/4000
PURE SINE WAVE INVERTER

FR

[Page 41]

SP-700/1000/1500/2000/3000/4000
Signal de sortie sinusoïdal pur

Table of Content

1. SAFETY INSTRUCTIONS	3
1-1. General Safety Precautions	3
1-2. Other Safety Notes	4
2. FUNCTIONAL CHARACTERISTICS INTRODUCTION	5
2-1. System	5
2-2. Block Diagram	5
2-3. Electrical Specification	6
2-3-1. SP-700 Specification	6
2-3-2. SP-1000 Specification	8
2-3-3. SP-1500 Specification	10
2-3-4. SP-2000 Specification	12
2-3-5. SP-3000 Specification	14
2-3-6. SP-4000 Specification	16
2-3-7. Voltage & temperature performance	18
2-4. Mechanical Drawings	19
3. INSTALLATION AND MAINTENANCE	20
3-1. AC Output Side (Front Panel) Introduction	20
3-1-1. Main Switch	21
3-1-2. LED Indicator	21
3-1-3. Function Switch Introduction	22
3-1-4. TRC Port (for optional kits TR-40, RJ-45)	23
3-1-5. AC output Interface	24

3-2. DC Input Side (Rear Panel) Introduction	26
3-2-1. Remote Port (RJ-11)	27
3-2-2. Remote Control Green Terminal	27
3-2-3. General instruction before DC Input	28
3-2-4. Chassis Ground	29
3-3. Maintenance	29
4. OPERATION	30
4-1. Connection the DC cable	30
4-2. Connecting the input power	31
4-3. Connecting the loads	31
4-4. Switch ON Inverter	31
4-5. Protection Mechanism	32
5. RS-232 COMMUNICATION AND OPERATION	32
5-1. RS-232 Port	32
5-2. RS-232 Port Operating	33
5-3. Example of RS-232 Port Operating	33
5-3-1. RS-232 command format	33
5-3-2. Command format	33
6. INFORMATION	38
6-1. Warning	38
6-2. Warranty	38

1. Safety Instructions

1-1. General Safety Precautions



Warning! Before using the Inverter, read the safety instructions.

- Do not expose the inverter to rain, snow, spray or dust. To reduce the risk of fire hazard, do not cover or obstruct the ventilation openings and do not install the inverter in a zero-clearance compartment.
- To avoid the risk of fire and electric shock, make sure that the existing wiring is in good electrical condition, and the wire size is not undersized.
- This equipment contains components which can produce arcs or sparks. To prevent fire or explosion do not install in compartment containing batteries or flammable materials or in location which require ignition protected equipment. This includes any space containing gasoline-powered machinery, fuel tanks, or joints, fittings, or other connection between components of the fuel system.
- Depending on the user scenario, the AC output of the inverter may require user installed breaker or fuse. In AC output hardwire application, AC socket will not be provided. The inverter incorporates standard AC short circuit protection.
- An over current protection at the time of installation shall be provided by others for the AC output circuit.
- Additional breakers suitable for 20 A branch circuit protection shall be provided for the GFCI receptacles.
- The following precautions should be taken when working on the inverter:
 - Step 1 Remove watches, rings, or other metal objects
 - Step 2 Use tools with insulated handles
 - Step 3 Wear rubber gloves and boots

1-2. Other Safety Notes

- Upon receipt, examine the carton box for damage. If you have found any damage on the carton box please notify the company you purchased this unit from.
- Do not operate near water or in excessive humidity.
- Do not open or disassemble the inverter, and warranty may be voided.
- The DC side connections should be firm and tight.
- Grounding: Reliable grounding should be maintained.
- Do not drop a metal tool on the battery. The resulting spark or short-circuit on the battery or on the other electrical part may cause an explosion.
- Install the inverter in a well-ventilated area. Do not block the front air vents, or the rear air exhausts of the unit.
- Wiring: Adequate input power must be supplied to the inverter for proper use; correct wiring sizes must be ensured.
- Mount the inverter such that the fan axis is horizontal.
- Do not operate the inverter close to combustible gas or open fire.
- Do not operate appliances that may feed power back into the inverter.
- Temperature: The inverter should be operated in an ambient temperature range of -20°C to 40°C otherwise the output efficiency may be affected. Air flow to the inverter must not be blocked.

2. Functional Characteristics Introduction

2-1. System

The unit is a highly reliable DC-AC inverter system, designed with advanced power electronic and microprocessor technology offering the following features:

- Pure sine wave output waveform O/P voltage 1xx: THD < 5 %, 2xx: THD < 3 %
- Optional bypass relay (TR-40) function
- Intelligent software for power management
- Loading and temperature controlled cooling fan
- CR-8/CR-16 remote management and control
- RS-232 communication
- Dry contact terminal
- Advanced Protection Features
 - Input over/under voltage protection
 - Internal over temperature protection
 - Input reverse polarity protection (Fuse)
 - Output overload protection
 - Output short circuit protection

2-2. Block Diagram

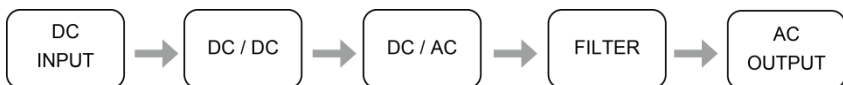

2-3. Electrical Specification

2-3-1. SP-700 Specification

Electrical	Specification	Model No.		
	Item	SP-700-112	SP-700-124	SP-700-148
Input Characteristics	Voltage	12VDC	24VDC	48VDC
	Input Over-Voltage Protection ^①	16.5 ± 0.3VDC	33 ± 0.5VDC	66 ± 1.0VDC
	Input Under-Voltage Protection	10.5 ± 0.3VDC	21 ± 0.5VDC	42 ± 1.0VDC
	Voltage Range	10.5~16.5VDC	21~33VDC	42~66VDC
	No Load Current	≤1.5A @12VDC	≤0.8A @24VDC	≤0.5A @48VDC
	Power Saving Mode	<0.1A @12VDC	<0.06A @24VDC	<0.05A @48VDC
Output Characteristics	Continuous Output Power	700 VA (± 3%)		
	Maximum output Power (1Min)	> 700 VA~810 VA (100%~115%)		
	Surge Power (Max. 3 Sec)	< 1230 VA		
	Frequency	50 / 60 Hz ± 0.5% (Dip Switch Selectable)		
	Output Voltage	100 / 110 / 115 / 120 VAC (± 5%) (Dip Switch Selectable)		
	Efficiency max.	91%	93%	93%
	Short-Circuit Protection	1 Sec Shutdown		
Output Waveform ^②	Pure Sine Wave (THD < 5% @ Normal Load)			
Signal and Control	Remote Controller Panel Unit	CR-8 / CR-16 (optional)		
	LED Indicator	Red / Orange / Green LED		
	Dry Contact Terminal	By a relay		
	Remote Control Terminal	6-port Green terminal (for inverter ON / OFF)		
Protection	Input Protection	Over / Under Voltage, Reverse Polarity (Internal Fuse)		
	AC Output Protection	Short-Circuit, Overload		
	Others	Over / Under Temperature Protection (by Heat sink Temperature +80°C/-20°C)		
Environment	Operating Temp. ^③	-20 °C~40 °C		
	Storage Temp.	-30 °C~70 °C		
	Storage Temp. & Humidity	10 ~95% RH		
Safety & EMC	Safety Standards	Certified UL 458 (UL only for GFCI receptacles)		----
	EMC standards	Certified FCC class B		
	E-mark	----		
Dimension(WxHxD)		200mm X 83mm X 330mm		
Weight		2.6 KG		
Cooling		Temperature & Load Controlled cooling Fan		
AC Transfer Function Accessories		TR-40 (optional)		

Table 1. SP-700 for Output 100/110/115/120 VAC Specification.



Note :

- ① Voltage range : Please refer to Figure 1
- ② Normal load Condition : Vin =12.5V/25V/50V, Vo=100/110/115/120 VAC 80% load (PF=1.0)
- ③ Operating temperature : Please refer to Figure 2

Electrical	Specification	Model No.		
	Item	SP-700-212	SP-700-224	SP-700-248
Input Characteristics	Voltage	12VDC	24VDC	48VDC
	Input Over-Voltage Protection ①	16.5 ± 0.3VDC	33 ± 0.5VDC	66 ± 1.0VDC
	Input Under-Voltage Protection	10.5 ± 0.3VDC	21 ± 0.5VDC	42 ± 1.0VDC
	Voltage Range	10.5~16.5VDC	21~33VDC	42~66VDC
	No Load Current	≤ 1.5A @12VDC	≤ 0.8A @24VDC	≤ 0.5A @48VDC
	Power Saving Mode	<0.1A @12VDC	<0.06A @24VDC	<0.05A @48VDC
Output Characteristics	Continuous Output Power	700 VA (± 3%)		
	Maximum output Power (1Min)	> 700 VA~810 VA (100%~115%)		
	Surge Power (Max. 3 Sec)	< 1230 VA		
	Frequency	50 / 60 Hz ± 0.5% (Dip Switch Selectable)		
	Output Voltage	200 / 220 / 230 / 240 VAC (± 3%) (Dip Switch Selectable)		
	Efficiency max.	91%	93%	94%
	Short-Circuit Protection	1 Sec Shutdown		
	Output Waveform ②	Pure Sine Wave (THD < 3% @ Normal Load)		
Signal and Control	Remote Controller Panel Unit	CR-8 / CR-16 (optional)		
	LED Indicator	Red / Orange / Green LED		
	Dry Contact Terminal	By a relay		
	Remote Control Terminal	6-port Green terminal (for inverter ON / OFF)		
Protection	Input Protection	Over / Under Voltage, Reverse Polarity (Internal Fuse)		
	AC Output Protection	Short-Circuit, Overload		
	Others	Over / Under Temperature Protection (by Heat sink Temperature +80°C/-20°C)		
Environment	Operating Temp. ③	-20 °C ~ -40 °C		
	Storage Temp.	-30 °C ~ -70 °C		
	Storage Temp. & Humidity	10 ~95% RH		
Safety & EMC	Safety Standards	Certified EN 60950-1		
	EMC standards	Certified EN 55022 class B; EN 55024; EN 61000-3-2, -3-3 EN 61000-4-2, 3, 4, 5, 6, 8, 11		
	E-mark	Certified CISPR 25; ISO 7637-2		
Dimension(WxHxD)		200mm X 83mm X 330mm		
Weight		2.6 KG		
Cooling		Temperature & Load Controlled cooling Fan		
AC Transfer Function Accessories		TR-40 (optional)		

Table 2. SP-700 for Output 200/220/230/240 VAC Specification.



Note :

① Voltage range : Please refer to Figure 1

② Normal load Condition : Vin =12.5V/25V/50V, Vo=200/220/230/240 VAC 80% load (PF=1.0)

③ Operating temperature : Please refer to Figure 2

2-3-2. SP-1000 Specification

Electrical	Specification	Model No.		
	Item	SP-1000-112	SP-1000-124	SP-1000-148
Input Characteristics	Voltage	12VDC	24VDC	48VDC
	Input Over-Voltage Protection ^①	16.5 ± 0.3VDC	33 ± 0.5VDC	66 ± 1.0VDC
	Input Under-Voltage Protection	10.5 ± 0.3VDC	21 ± 0.5VDC	42 ± 1.0VDC
	Voltage Range	10.5~16.5 VDC	21~33 VDC	42~66 VDC
	No Load Current	≤1.5A @12VDC	≤0.8A @24VDC	≤0.5A @48VDC
	Power Saving Mode	<0.1A @12VDC	<0.06A @24VDC	<0.05A @48VDC
Output Characteristics	Continuous Output Power	1000 VA (± 3%)		
	Maximum output Power (1Min)	> 1000 VA~1150 VA (100%~115%)		
	Surge Power (Max. 3 Sec)	< 1750 VA		
	Frequency	50 / 60 Hz ± 0.5% (Dip Switch Selectable)		
	Output Voltage	100 / 110 / 115 / 120 VAC (± 5%) (Dip Switch Selectable)		
	Efficiency max.	92%	93%	93%
	Short-Circuit Protection	1 Sec Shutdown		
Output Waveform ^②	Pure Sine Wave (THD < 5% @ Normal Load)			
Signal and Control	Remote Controller Panel Unit	CR-8 / CR-16 (optional)		
	LED Indicator	Red / Orange / Green LED		
	Dry Contact Terminal	By a relay		
	Remote Control Terminal	6-port Green terminal (for inverter ON / OFF)		
Protection	Input Protection	Over / Under Voltage, Reverse Polarity (Internal Fuse)		
	AC Output Protection	Short-Circuit, Overload		
	Others	Over / Under Temperature Protection (by Heat sink Temperature +80°C/-20°C)		
Environment	Operating Temp. ^③	-20 °C ~40 °C		
	Storage Temp.	-30 °C ~70 °C		
	Storage Temp. & Humidity	10 ~95% RH		
Safety & EMC	Safety Standards	Certified UL 458 (UL only for GFCI receptacles)		----
	EMC standards	Certified FCC class B		
	E-mark	----		
Dimension(WxHxD)		200mm X 83mm X 372mm		
Weight		3.26 KG		
Cooling		Temperature & Load Controlled cooling Fan		
AC Transfer Function Accessories		TR-40 (optional)		

Table 3. SP-1000 for Output 100/110/115/120 VAC Specification.

**Note :**

- ① Voltage range : Please refer to Figure 1
 ② Normal load Condition : Vin =12.5V/25V/50V, Vo=100/110/115/120 VAC 80% load (PF=1.0)
 ③ Operating temperature : Please refer to Figure 2

Electrical	Specification	Model No.		
	Item	SP-1000-212	SP-1000-224	SP-1000-248
Input Characteristics	Voltage	12VDC	24VDC	48VDC
	Input Over-Voltage Protection ^①	16.5 ± 0.3VDC	33 ± 0.5VDC	66 ± 1.0VDC
	Input Under-Voltage Protection	10.5 ± 0.3VDC	21 ± 0.5VDC	42 ± 1.0VDC
	Voltage Range	10.5~16.5 VDC	21~33 VDC	42~66 VDC
	No Load Current	≤ 1.5A @12VDC	≤ 0.8A @24VDC	≤ 0.4A @48VDC
	Power Saving Mode	< 0.1A @12VDC	<0.05A @24VDC	<0.05A @48VDC
Output Characteristics	Continuous Output Power	1000 VA (± 3%)		
	Maximum output Power (1Min)	> 1000 VA~1150 VA (100%~115%)		
	Surge Power (Max. 3 Sec)	< 1750 VA		
	Frequency	50 / 60 Hz ± 0.5% (Dip Switch Selectable)		
	Output Voltage	200 / 220 / 230 / 240 VAC (± 3%) (Dip Switch Selectable)		
	Efficiency max.	92%	94%	94%
	Short-Circuit Protection	1 Sec Shutdown		
	Output Waveform ^②	Pure Sine Wave (THD < 3% @ Normal Load)		
Signal and Control	Remote Controller Panel Unit	CR-8 / CR-16 (optional)		
	LED Indicator	Red / Orange / Green LED		
	Dry Contact Terminal	By a relay		
	Remote Control Terminal	6-port Green terminal (for inverter ON / OFF)		
Protection	Input Protection	Over / Under Voltage, Reverse Polarity (Internal Fuse)		
	AC Output Protection	Short-Circuit, Overload		
	Others	Over / Under Temperature Protection (by Heat sink Temperature +80°C/-20°C)		
Environment	Operating Temp. ^③	-20 °C ~ -40 °C		
	Storage Temp.	-30 °C ~ -70 °C		
	Storage Temp. & Humidity	10 ~95% RH		
Safety & EMC	Safety Standards	Certified EN 60950-1		
	EMC standards	Certified EN 55022 class B; EN 55024; EN 61000-3-2, -3-3 EN 61000-4-2, 3, 4, 5, 6, 8, 11		
	E-mark	Certified CISPR 25; ISO 7637-2		
Dimension(WxHxD)		200mm X 83mm X 372mm		
Weight		3.26 KG		
Cooling		Temperature & Load Controlled cooling Fan		
AC Transfer Function Accessories		TR-40 (optional)		

Table 4. SP-1000 for Output 200/220/230/240 VAC Specification.



Note :

- ① Voltage range : Please refer to Figure 1
- ② Normal load Condition : Vin =12.5V/25V/50V, Vo=200/220/230/240 VAC 80% load (PF=1.0)
- ③ Operating temperature : Please refer to Figure 2

2-3-3. SP-1500 Specification

Electrical	Specification	Model No.		
	Item	SP-1500-112	SP-1500-124	SP-1500-148
Input Characteristics	Voltage	12VDC	24VDC	48VDC
	Input Over-Voltage Protection ^①	16.5 ± 0.3VDC	33 ± 0.5VDC	66 ± 1.0VDC
	Input Under-Voltage Protection	10.5 ± 0.3VDC	21 ± 0.5VDC	42 ± 1.0VDC
	Voltage Range	10.5~16.5 VDC	21~33 VDC	42~66 VDC
	No Load Current	≤1.8A @12VDC	≤1.0A @24VDC	≤0.5A @48VDC
	Power Saving Mode	<0.1A @12VDC	<0.05A @24VDC	<0.05A @48VDC
Output Characteristics	Continuous Output Power	1500 VA (± 3%)		
	Maximum output Power (1Min)	> 1500 VA~1730VA (100%~115%)		
	Surge Power (Max. 3 Sec)	<2650 VA		
	Frequency	50 / 60 Hz ± 0.5% (Dip Switch Selectable)		
	Output Voltage	100 / 110 / 115 / 120 VAC (± 5%) (Dip Switch Selectable)		
	Efficiency max.	91%	92%	93%
	Short-Circuit Protection	1 Sec Shutdown		
Output Waveform ^②	Pure Sine Wave (THD < 5% @ Normal Load)			
Signal and Control	Remote Controller Panel Unit	CR-8 / CR-16 (optional)		
	LED Indicator	Red / Orange / Green LED		
	Dry Contact Terminal	By a relay		
	Remote Control Terminal	6-port Green terminal (for inverter ON / OFF)		
Protection	Input Protection	Over / Under Voltage, Reverse Polarity (Internal Fuse)		
	AC Output Protection	Short-Circuit, Overload		
	Others	Over / Under Temperature Protection (by Heat sink Temperature +80°C/-20°C)		
Environment	Operating Temp. ^③	-20 °C ~40 °C		
	Storage Temp.	-30 °C ~70 °C		
	Storage Temp. & Humidity	10 ~95% RH		
Safety & EMC	Safety Standards	Certified UL 458 (UL only for GFCI receptacles)		----
	EMC standards	Certified FCC class B		
	E-mark	----		
Dimension(WxHxD)		248mm X 83mm X 421mm		
Weight		4.14 KG		
Cooling		Temperature & Load Controlled cooling Fan		
AC Transfer Function Accessories		TR-40 (optional)		

Table 5. SP-1500 for Output 100/110/115/120 VAC Specification.

**Note :**

- ① Voltage range : Please refer to Figure 1
 ② Normal load Condition : Vin =12.5V/25V/50V, Vo=100/110/115/120VAC 80% load (PF=1.0)
 ③ Operating temperature : Please refer to Figure 2

Electrical	Specification	Model No.		
	Item	SP-1500-212	SP-1500-224	SP-1500-248
Input Characteristics	Voltage	12VDC	24VDC	48VDC
	Input Over-Voltage Protection ^①	16.5 ± 0.3VDC	33 ± 0.5VDC	66 ± 1.0VDC
	Input Under-Voltage Protection	10.5 ± 0.3VDC	21 ± 0.5VDC	42 ± 1.0VDC
	Voltage Range	10.5~16.5 VDC	21~33 VDC	42~66 VDC
	No Load Current	≤ 1.8A @12VDC	≤ 1.0A @24VDC	≤ 0.5A @48VDC
	Power Saving Mode	<0.1A @12VDC	<0.05A @24VDC	<0.05A @48VDC
Output Characteristics	Continuous Output Power	1500 VA (± 3%)		
	Maximum output Power (1Min)	> 1500 VA~1730VA (100%~115%)		
	Surge Power (Max. 3 Sec)	<2650 VA		
	Frequency	50 / 60 Hz ± 0.5% (Dip Switch Selectable)		
	Output Voltage	200 / 220 / 230 / 240 VAC (± 3%) (Dip Switch Selectable)		
	Efficiency max.	93%	94%	94%
	Short-Circuit Protection	1 Sec Shutdown		
	Output Waveform ^②	Pure Sine Wave (THD < 3% @ Normal Load)		
Signal and Control	Remote Controller Panel Unit	CR-8 / CR-16 (optional)		
	LED Indicator	Red / Orange / Green LED		
	Dry Contact Terminal	By a relay		
	Remote Control Terminal	6-port Green terminal (for inverter ON / OFF)		
Protection	Input Protection	Over / Under Voltage, Reverse Polarity (Internal Fuse)		
	AC Output Protection	Short-Circuit, Overload		
	Others	Over / Under Temperature Protection (by Heat sink Temperature +80°C/-20°C)		
Environment	Operating Temp. ^③	-20 °C ~40 °C		
	Storage Temp.	-30 °C ~70 °C		
	Storage Temp. & Humidity	10 ~95% RH		
Safety & EMC	Safety Standards	Certified EN 60950-1		
	EMC standards	Certified EN 55022 class B; EN 55024; EN 61000-3-2, -3-3 EN 61000-4-2, 3, 4, 5, 6, 8, 11		
	E-mark	Certified CISPR 25; ISO 7637-2		
Dimension(WxHxD)		248mm X 83mm X 421mm		
Weight		4.14 KG		
Cooling		Temperature & Load Controlled cooling Fan		
AC Transfer Function Accessories		TR-40 (optional)		

Table 6. SP-1500 for Output 200/220/230/240 VAC Specification.



Note :

- ① Voltage range : Please refer to Figure 1
- ② Normal load Condition : Vin =12.5V/25V/50V, Vo=200/220/230/240 VAC 80% load (PF=1.0)
- ③ Operating temperature : Please refer to Figure 2

2-3-4. SP-2000 Specification

Electrical	Specification	Model No.		
	Item	SP-2000-112	SP-2000-124	SP-2000-148
Input Characteristics	Voltage	12VDC	24VDC	48VDC
	Input Over-Voltage Protection ^①	16.5 ± 0.3VDC	33 ± 0.5VDC	66 ± 1.0VDC
	Input Under-Voltage Protection	10.5 ± 0.3VDC	21 ± 0.5VDC	42 ± 1.0VDC
	Voltage Range	10.5~16.5 VDC	21~33 VDC	42~66 VDC
	No Load Current	≤ 1.8A @12VDC	≤ 1.0A @24VDC	≤ 0.5A @48VDC
	Power Saving Mode	<0.1A @12VDC	<0.05A @24VDC	<0.05A @48VDC
Output Characteristics	Continuous Output Power	2000 VA (± 3%)		
	Maximum output Power (1Min)	> 2000 VA~2300 VA (100%~115%)		
	Surge Power (Max. 3 Sec)	< 3500 VA		
	Frequency	50 / 60 Hz ± 0.5% (Dip Switch Selectable)		
	Output Voltage	100 / 110 / 115 / 120 VAC (± 5%) (Dip Switch Selectable)		
	Efficiency max.	92%	93%	94%
	Short-Circuit Protection	1 Sec Shutdown		
	Output Waveform ^②	Pure Sine Wave (THD < 5% @ Normal Load)		
Signal and Control	Remote Controller Panel Unit	CR-8 / CR-16 (optional)		
	LED Indicator	Red / Orange / Green LED		
	Dry Contact Terminal	By a relay		
	Remote Control Terminal	6-port Green terminal (for inverter ON / OFF)		
Protection	Input Protection	Over / Under Voltage, Reverse Polarity (Internal Fuse)		
	AC Output Protection	Short-Circuit, Overload		
	Others	Over / Under Temperature Protection (by Heat sink Temperature +80°C/-20°C)		
Environment	Operating Temp. ^③	-20 °C ~40 °C		
	Storage Temp.	-30 °C ~70 °C		
	Storage Temp. & Humidity	10 ~95% RH		
Safety & EMC	Safety Standards	Certified UL 458 (UL only for GFCI receptacles)		----
	EMC standards ^④	Certified FCC class A		
	E-mark	----		
Dimension(WxHxD)		248mm X 83mm X 443mm		
Weight		5.24 KG		
Cooling		Temperature & Load Controlled cooling Fan		
AC Transfer Function Accessories		TR-40 (optional)		

Table 7. SP-2000 for Output 100/110/115/120 VAC Specification.

**Note :**

- ① Voltage range : Please refer to Figure 1
 ② Normal load Condition : Vin =12.5V/25V/50V, Vo=100/110/115/120 VAC 80% load (PF=1.0)
 ③ Operating temperature : Please refer to Figure 2
 ④ **Warning** : This is a class A product. In a domestic environment this product may cause radio

interference in which case the user may be required to take adequate measures.

Electrical	Specification	Model No.		
	Item	SP-2000-212	SP-2000-224	SP-2000-248
Input Characteristics	Voltage	12VDC	24VDC	48VDC
	Input Over-Voltage Protection ^①	16.5 ± 0.3VDC	33 ± 0.5VDC	66 ± 1.0VDC
	Input Under-Voltage Protection	10.5 ± 0.3VDC	21 ± 0.5VDC	42 ± 1.0VDC
	Voltage Range	10.5~16.5 VDC	21~33 VDC	42~66 VDC
	No Load Current	≤ 1.8A @12VDC	≤ 1.0A @24VDC	≤ 0.5A @48VDC
	Power Saving Mode	<0.1A @12VDC	<0.05A @24VDC	<0.05A @48VDC
Output Characteristics	Continuous Output Power	2000 VA (± 3%)		
	Maximum output Power (1Min)	> 2000 VA~2300 VA (100%~115%)		
	Surge Power (Max. 3 Sec)	< 3500 VA		
	Frequency	50 / 60 Hz ± 0.5% (Dip Switch Selectable)		
	Output Voltage	200 / 220 / 230 / 240 VAC (± 3%) (Dip Switch Selectable)		
	Efficiency max.	94%	94%	95%
	Short-Circuit Protection	1 Sec Shutdown		
	Output Waveform ^②	Pure Sine Wave (THD < 3% @ Normal Load)		
Signal and Control	Remote Controller Panel Unit	CR-8 / CR-16 (optional)		
	LED Indicator	Red / Orange / Green LED		
	Dry Contact Terminal	By a relay		
	Remote Control Terminal	6-port Green terminal (for inverter ON / OFF)		
Protection	Input Protection	Over / Under Voltage, Reverse Polarity (Internal Fuse)		
	AC Output Protection	Short-Circuit, Overload		
	Others	Over / Under Temperature Protection (by Heat sink Temperature +80℃/-20℃)		
Environment	Operating Temp. ^③	-20 ℃~40 ℃		
	Storage Temp.	-30 ℃~70 ℃		
	Storage Temp. & Humidity	10 ~95% RH		
Safety & EMC	Safety Standards	Certified EN 60950-1		
	EMC standards ^④	Certified EN 55022 class A; EN 55024; EN 61000-3-2, -3-3 EN 61000-4-2, 3, 4, 5, 6, 8, 11		
	E-mark	Certified CISPR 25; ISO 7637-2		
Dimension(WxHxD)		248mm X 83mm X 443mm		
Weight		5.24 KG		
Cooling		Temperature & Load Controlled cooling Fan		
AC Transfer Function Accessories		TR-40 (optional)		

Table 8. SP-2000 for Output 200/220/230/240 VAC Specification.



Note :

- ① Voltage range : Please refer to Figure 1
- ② Normal load Condition : Vin =12.5V/25V/50V, Vo=200/220/230/240 VAC 80% load (PF=1.0)
- ③ Operating temperature : Please refer to Figure 2
- ④ **Warning** : This is a class A product. In a domestic environment this product may cause radio

interference in which case the user may be required to take adequate measures.

2-3-5. SP-3000 Specification

Electrical	Specification	Model No.		
	Item	SP-3000-112	SP-3000-124	SP-3000-148
Input Characteristics	Voltage	12VDC	24VDC	48VDC
	Input Over-Voltage Protection ^①	16.5 ± 0.3VDC	33 ± 0.5VDC	66 ± 1.0VDC
	Input Under-Voltage Protection	10.5 ± 0.3VDC	21 ± 0.5VDC	42 ± 1.0VDC
	Voltage Range	10.5~16.5 VDC	21~33 VDC	42~66 VDC
	No Load Current	≤3.8A @12VDC	≤2.0A @24VDC	≤1.0A @48VDC
Power Saving Mode	<0.4A @12VDC	<0.2A @24VDC	<0.1A @48VDC	
Output Characteristics	Continuous Output Power	3000 VA (± 3%)		
	Maximum output Power (1Min)	> 3000 VA~3450 VA (100%~115%)		
	Surge Power (1Sec)	< 6000 VA		
	Frequency	50 / 60 Hz ± 0.5% (Dip Switch Selectable)		
	Output Voltage	100 / 110 / 115 / 120 VAC (± 5%) (Dip Switch Selectable)		
	Efficiency max.	90%	91%	92%
	Short-Circuit Protection	1 Sec Shutdown		
Output Waveform ^②	Pure Sine Wave (THD < 5% @ Normal Load)			
Signal and Control	Remote Controller Panel Unit	CR-8 / CR-16 (optional)		
	LED Indicator	Red / Orange / Green LED		
	Dry Contact Terminal	By a relay		
	Remote Control Terminal	6-port Green terminal (for inverter ON / OFF)		
Protection	Input Protection	Over / Under Voltage, Reverse Polarity (Internal Fuse)		
	AC Output Protection	Short-Circuit, Overload		
	Others	Over / Under Temperature Protection (by Heat sink Temperature +80°C/-20°C)		
Environment	Operating Temp. ^③	-20 °C ~ 40 °C		
	Storage Temp.	-30 °C ~ 70 °C		
	Storage Temp. & Humidity	10 ~95% RH		
Safety & EMC	Safety Standards	Certified UL 458		----
	EMC standards ^④	Certified FCC class A		
	E-mark	----		
Dimension(WxHxD)		255mm X 158mm X 442mm		
Weight		8.2 KG		
Cooling		Temperature & Load Controlled cooling Fan		
AC Transfer Function Accessories		TR-40 (optional)		

Table 9. SP-3000 for Output 100/110/115/120 VAC Specification.



Note :

- ① Voltage range : Please refer to Figure 3
- ② Normal load Condition : $V_{in} = 12.5V/25V/50V$, $V_o = 100/110/115/120$ VAC 80% load (PF=1.0)
- ③ Operating temperature : Please refer to Figure 4
- ④ **Warning** : This is a class A product. In a domestic environment this product may cause radio interference in which case the user may be required to take adequate measures.

Electrical	Specification	Model No.		
	Item	SP-3000-212	SP-3000-224	SP-3000-248
Input Characteristics	Voltage	12VDC	24VDC	48VDC
	Input Over-Voltage Protection ^①	16.5 ± 0.3VDC	33 ± 0.5VDC	66 ± 1.0VDC
	Input Under-Voltage Protection	10.5 ± 0.3VDC	21 ± 0.5VDC	42 ± 1.0VDC
	Voltage Range	10.5~16.5 VDC	21~33 VDC	42~66 VDC
	No Load Current	≤3.8A @12VDC	≤2.0A @24VDC	≤1.0A @48VDC
	Power Saving Mode	<0.4A @12VDC	<0.2A @24VDC	<0.1A @48VDC
Output Characteristics	Continuous Output Power	3000 VA (± 3%)		
	Maximum output Power (1Min)	> 3000 VA~3450 VA (100%~115%)		
	Surge Power (1Sec)	< 6000 VA		
	Frequency	50 / 60 Hz ± 0.5% (Dip Switch Selectable)		
	Output Voltage	200 / 220 / 230 / 240 VAC (± 3%) (Dip Switch Selectable)		
	Efficiency max.	90%	93%	94%
	Short-Circuit Protection	1 Sec Shutdown		
Output Waveform ^②	Pure Sine Wave (THD < 3% @ Normal Load)			
Signal and Control	Remote Controller Panel Unit	CR-8 / CR-16 (optional)		
	LED Indicator	Red / Orange / Green LED		
	Dry Contact Terminal	By a relay		
	Remote Control Terminal	6-port Green terminal (for inverter ON / OFF)		
Protection	Input Protection	Over / Under Voltage, Reverse Polarity (Internal Fuse)		
	AC Output Protection	Short-Circuit, Overload		
	Others	Over / Under Temperature Protection (by Heat sink Temperature +80°C/-20°C)		
Environment	Operating Temp. ^③	-20 °C ~ -40 °C		
	Storage Temp.	-30 °C ~ -70 °C		
	Storage Temp. & Humidity	10 ~95% RH		
Safety & EMC	Safety Standards	Certified EN 60950-1		
	EMC standards ^④	Certified EN 55022 class A; EN 55024; EN 61000-3-2, -3-3 EN 61000-4-2, 3, 4, 5, 6, 8, 11		
	E-mark	Certified CISPR 25; ISO 7637-2		
Dimension(WxHxD)		255mm X 158mm X 442mm		
Weight		8.2 KG		
Cooling		Temperature & Load Controlled cooling Fan		
AC Transfer Function Accessories		TR-40 (optional)		

Table 10. SP-3000 for Output 200/220/230/240 VAC Specification.



Note :

- ① Voltage range : Please refer to Figure 3
- ② Normal load Condition : Vin =12.5V/25V/50V, Vo=200/220/230/240 VAC 80% load (PF=1.0)
- ③ Operating temperature : Please refer to Figure 4
- ④ **Warning** : This is a class A product. In a domestic environment this product may cause radio interference in which case the user may be required to take adequate measures.

2-3-6. SP-4000 Specification

Electrical	Specification	Model No.	
	Item	SP-4000-124	SP-4000-148
Input Characteristics	Voltage	24VDC	48VDC
	Input Over-Voltage Protection ^①	33 ± 0.5VDC	66 ± 1.0VDC
	Input Under-Voltage Protection	21 ± 0.5VDC	42 ± 1.0VDC
	Voltage Range	21~33 VDC	42~66 VDC
	No Load Current	≤2.0A @24VDC	≤1.0A @48VDC
	Power Saving Mode	<0.2A @24VDC	<0.1A @48VDC
Output Characteristics	Continuous Output Power	4000 VA (± 3%)	
	Maximum output Power (1Min)	> 4000 VA~4600 VA (100%~115%)	
	Surge Power (1Sec)	< 8000 VA	
	Frequency	50 / 60 Hz ± 0.5% (Dip Switch Selectable)	
	Output Voltage	100 / 110 / 115 / 120 VAC (± 5%) (Dip Switch Selectable)	
	Efficiency max.	91%	91%
	Short-Circuit Protection	1 Sec Shutdown	
Output Waveform ^②	Pure Sine Wave (THD < 5% @ Normal Load)		
Signal and Control	Remote Controller Panel Unit	CR-8 / CR-16 (optional)	
	LED Indicator	Red / Orange / Green LED	
	Dry Contact Terminal	By a relay	
	Remote Control Terminal	6-port Green terminal (for inverter ON / OFF)	
Protection	Input Protection	Over / Under Voltage, Reverse Polarity (Internal Fuse)	
	AC Output Protection	Short-Circuit, Overload	
	Others	Over / Under Temperature Protection (by Heat sink Temperature +80℃/-20℃)	
Environment	Operating Temp. ^③	-20 ℃ ~40 ℃	
	Storage Temp.	-30 ℃ ~70 ℃	
	Storage Temp. & Humidity	10 ~95% RH	
Safety & EMC	Safety Standards	Certified UL 458	----
	EMC standards ^④	Certified FCC class A	
	E-mark	----	
Dimension(WxHxD)		255mm X 158mm X 462mm	
Weight		10 KG	
Cooling		Temperature & Load Controlled cooling Fan	
AC Transfer Function Accessories		TR-40 (optional)	

Table 11. SP-4000 for Output 100/110/115/120 VAC Specification.

**Note :**

- ① Voltage range : Please refer to Figure 3
- ② Normal load Condition : $V_{in}=12.5V/25V/50V$, $V_o=100/110/115/120$ VAC 80% load (PF=1.0)
- ③ Operating temperature : Please refer to Figure 4
- ④ **Warning** : This is a class A product. In a domestic environment this product may cause radio interference in which case the user may be required to take adequate measures.

Electrical	Specification	Model No.	
	Item	SP-4000-224	SP-4000-248
Input Characteristics	Voltage	24VDC	48VDC
	Input Over-Voltage Protection ^①	33 ± 0.5VDC	66 ± 1.0VDC
	Input Under-Voltage Protection	21 ± 0.5VDC	42 ± 1.0VDC
	Voltage Range	21~33 VDC	42~66 VDC
	No Load Current	≤2.0A @24VDC	≤1.0A @48VDC
	Power Saving Mode	<0.2A @24VDC	<0.1A @48VDC
Output Characteristics	Continuous Output Power	4000 VA (± 3%)	
	Maximum output Power (1Min)	> 4000 VA~4600 VA (100%~115%)	
	Surge Power (1Sec)	< 8000 VA	
	Frequency	50 / 60 Hz ± 0.5% (Dip Switch Selectable)	
	Output Voltage	200 / 220 / 230 / 240 VAC (± 3%) (Dip Switch Selectable)	
	Efficiency max.	90%	91%
	Short-Circuit Protection	1 Sec Shutdown	
Output Waveform ^②	Pure Sine Wave (THD < 3% @ Normal Load)		
Signal and Control	Remote Controller Panel Unit	CR-8 / CR-16 (optional)	
	LED Indicator	Red / Orange / Green LED	
	Dry Contact Terminal	By a relay	
	Remote Control Terminal	6-port Green terminal (for inverter ON / OFF)	
Protection	Input Protection	Over / Under Voltage, Reverse Polarity (Internal Fuse)	
	AC Output Protection	Short-Circuit, Overload	
	Others	Over / Under Temperature Protection (by Heat sink Temperature +80℃/-20℃)	
Environment	Operating Temp. ^③	-20 ℃ ~40 ℃	
	Storage Temp.	-30 ℃ ~70 ℃	
	Storage Temp. & Humidity	10 ~95% RH	
Safety & EMC	Safety Standards	Certified EN 60950-1	
	EMC standards ^④	Certified EN 55022 class A; EN 55024; EN 61000-3-2, -3-3; EN 61000-4-2, 3, 4, 5, 6, 8, 11	
	E-mark	Certified CISPR 25; ISO 7637-2	
Dimension(WxHxD)		255mm X 158mm X 462mm	
Weight		10 KG	
Cooling		Temperature & Load Controlled cooling Fan	
AC Transfer Function Accessories		TR-40 (optional)	

Table 12. SP-4000 for Output 100/110/115/120 VAC Specification.



Note :

- ① Voltage range : Please refer to Figure 3
- ② Normal load Condition : Vin =25V/50V, Vo=200/220/230/240 VAC 80% load (PF=1.0)
- ③ Operating temperature : Please refer to Figure 4
- ④ **Warning** : This is a class A product. In a domestic environment this product may cause radio interference in which case the user may be required to take adequate measures.

2-3-7. Voltage & temperature performance

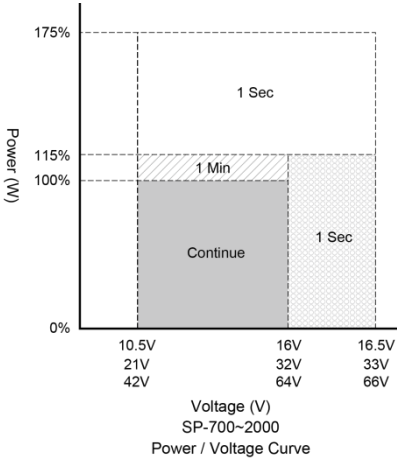

Figure 1. SP-700~2000
Output power vs. input voltage

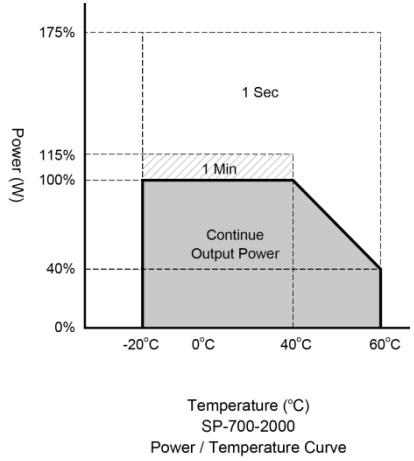

Figure 2. SP-700~2000
Output power vs. temperature

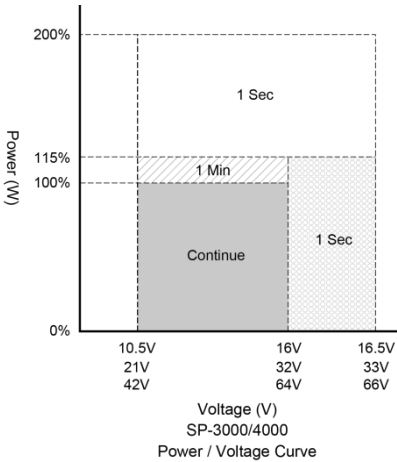

Figure 3. SP-3000/4000
Output power vs. input voltage

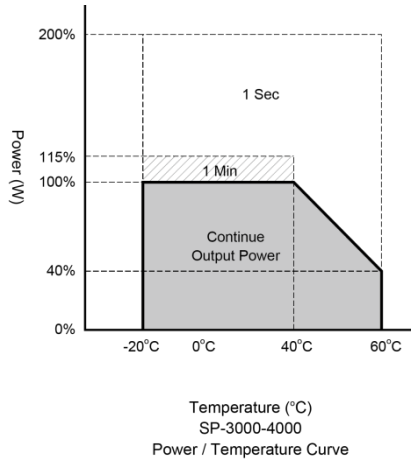

Figure 4. SP-3000/4000
Output power vs. temperature

2-4. Mechanical Drawings

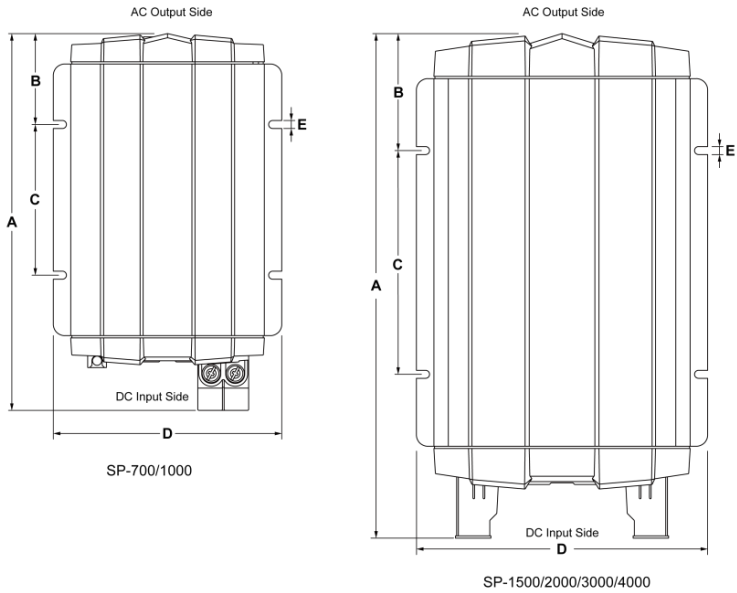

Figure 5. SP series drawing (Top View)

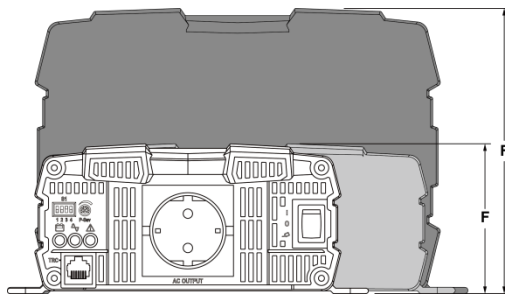

Figure 6. SP series drawing (AC output/Front View)

Model	A (mm)	B (mm)	C (mm)	D (mm)	E (mm)	F (mm)
SP-700	330	80	132	200	7.0	83
SP-1000	372	69	196	200	7.0	83
SP-1500	421	92	196	248	7.0	83
SP-2000	443	103	196	248	7.0	83
SP-3000	442	103	196	255	7.0	158
SP-4000	462	113	196	255	7.0	158

Table 13. SP Series Dimension

3. Installation and Maintenance

3-1. AC Output Side (Front Panel) Introduction

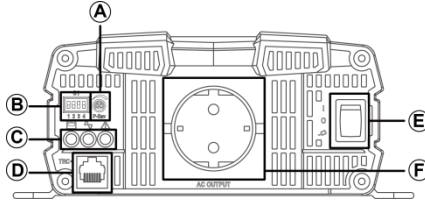

Figure 7. SP-700/1000 AC output panel view

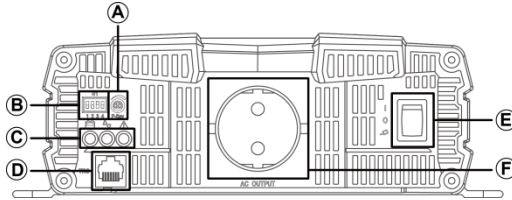

Figure 8. SP-1500/2000 AC output panel view

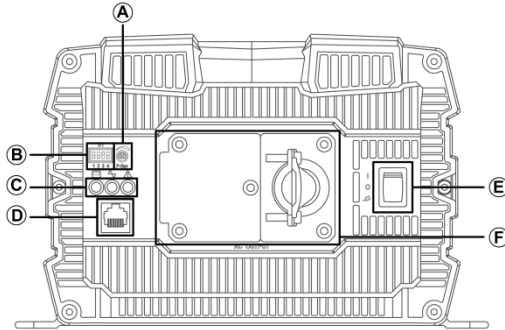

Figure 9. SP-3000/4000 AC output panel view

Model	SP-700	SP-1000	SP-1500	SP-2000	SP-3000	SP-4000
(A)	Saving power adjustment					
(B)	Function switch					
(C)	Function LED					
(D)	TRC port (RJ-45)					
(E)	Main switch					
(F)	AC output socket				AC output terminal	

Table 14. SP Series AC output side introduction

3-1-1. Main Switch

The 3-stage switch (E) is for turning on, turning off and remote mode.

3-1-2. LED Indicator

3-1-2-1. Input voltage level: to display Input Voltages

LED status (C)	DC 12V	DC 24V	DC 48V
Red	< 11.0V	< 22.0V	< 44.0V
Orange	11.0 ~ 11.5V	22.0 ~ 23.0V	44.0~46.0V
Green	11.5 ~ 15.0V	23.0 ~ 30.0V	46.0~60.0V
Orange	15.0 ~ 15.5V	30.0 ~ 31.0V	60.0~62.0V
Red	>15.5V	>31.0V	>62.0V

Table 15. Input Voltage Level LED Indicator

3-1-2-2. Output Load Level to display AC Loads (PF=1)

LED status (C)	Green	Orange	Red
SP-700	0 ~ 700 VA	700 ~ 805 VA	> 805 VA
SP-1000	0 ~ 1000 VA	1000 ~ 1150 VA	> 1150 VA
SP-1500	0 ~ 1500 VA	1500 ~ 1725 VA	> 1725 VA
SP-2000	0 ~ 2000 VA	2000 ~ 2300 VA	> 2300 VA
SP-3000	0 ~ 3000 VA	3000 ~ 3450 VA	> 3450 VA
SP-4000	0 ~ 4000 VA	4000 ~ 4600 VA	> 4600 VA

Table 16. Output Load Level LED Indicator

3-1-2-3. Inverter Status to display Fault condition

LED status (C)	Status	Recovery point
Green	Normal	
Red	Over Current Protection / Over Load Protection (AC output short-circuit and over load)	
Red Blink	Under Voltage Protection (Input DC voltage under spec)	12.5V @ DC12V system 25V @ DC24V system 50V @ DC48V system
Red Fast Blink	Over Voltage Protection (Input DC voltage over spec)	14.5V @ DC12V system 29V @ DC24V system 58V @ DC48V system

LED status ③	Status	Recovery point
Orange	Device startup process abnormal	—
Orange Fast Blink	Under Temperature Protection (Heat sink temp. under -20°C)	> 0°C
Orange Slow Blink	Over Temperature Protection (Heat sink temp. over 80°C)	< 60°C (heat sink temperature)

Table 17. Inverter LED Status Indicator

3-1-3. Function Switch Introduction

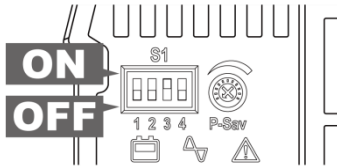

Figure 10. DIP switch ON/OFF position

3-1-3-1. Function Switch Definition

Dip Switch ③	Function
S1	Voltage select
S2	Voltage select
S3	Frequency Select
S4	Power saving ON/OFF

Table 18. Function Switch Definition

3-1-3-2. Output voltage selection (S1&S2)

Output voltage	S1	S2
100V/200V	OFF	OFF
110V/220V	ON	OFF
115V/230V	OFF	ON
120V/240V	ON	ON

Table 19. Function Switch definition: output voltage selection



Note! 100V series can be selected between 100/110/115/120VAC, and 200V series can be selected between 200/220/230/240VAC.

3-1-3-3. Output Frequency Selection (S3)

Frequency	S3
50Hz	OFF
60Hz	ON

Table 20. Function Switch definition: Output Frequency selection

3-1-3-4. Power Saving Selection (S4)

Saving function	S4
Power Saving OFF	OFF
Power Saving ON	ON

Table 21. Function Switch definition: Power Saving selection

3-1-3-5. Power Saving Load Adjustment

User can use variable resistor (VR) to set the input and wake up power saving threshold according to the load condition, and the setting range shows below:

Ⓐ	Input Saving Power (Min)	Saving Wake up Power (Min)
SP-700	<20 VA	>40 VA
SP-1000	<20 VA	>40 VA
SP-1500	<20 VA	>40 VA
SP-2000	<20 VA	>40 VA
SP-3000	<40 VA	>60 VA
SP-4000	<40 VA	>60 VA

Table 22. Power saving setting range (Min)

Ⓐ	Input Saving Power (Max)	Saving Wake up Power (Max)
SP-700	<110 VA	>160 VA
SP-1000	<110 VA	>160 VA
SP-1500	<110 VA	>160 VA
SP-2000	<110 VA	>160 VA
SP-3000	<240 VA	>280 VA
SP-4000	<240 VA	>280 VA

Table 23. Power saving setting range (Max)

3-1-4. TRC Port (for optional kits TR-40, RJ-45)

Pin Number	Signal Description Ⓓ	
1	Reserved	--
2	PH-L	Zero-Crossing Signal
3	PH-N	Zero-Crossing Signal

Pin Number	Signal Description (D)	
4	Bypass	Transfer Relay Driver Signal
5	12V	Internal power for TR40 controller
6	5V	Internal power for TR40 controller
7	GND	The same polarity as the battery negative side
8	Reserved	--

Table 24. SP Series TRC Port : RJ-45.

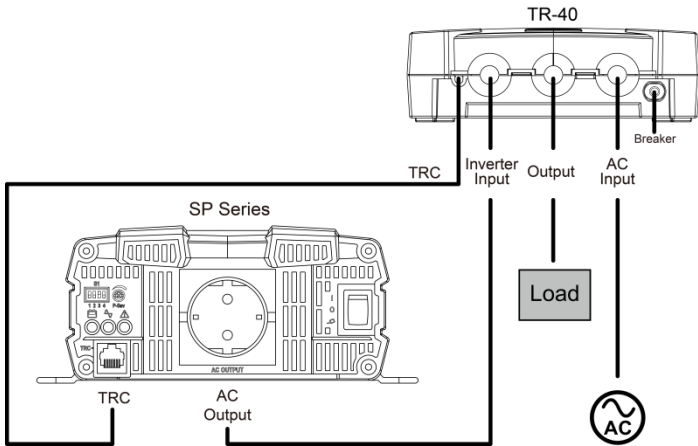

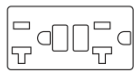



Figure 11. Wiring between SP series and TR-40



Note! The detail information please refer to TR-40 user manual

3-1-5. AC output Interface

3-1-5-1. SP-700/1000/1500/2000 AC output interface

Socket Type (F)	Applicable Model
 North America (GFCI)  NEMA 5-15R	SP-700/1000-112/124/148
 North America (GFCI)  NEMA 5-20R	SP-1500/2000-112/124/148



Socket Type (F)	Applicable Model
 <p>Australia / New Zealand Continental European UK</p>	SP-700/1000/1500/2000/3000-212/224/248
 <p>Universal</p>	SP-700/1000/1500/2000-112/124/148 SP-700/1000/1500/2000/3000-212/224/248
 <p>Hard Wire</p>	SP-3000-112/124/148/212/224/248 SP-4000-124/148/224/248
 <p>France Connector</p>	SP-700/1000/1500/2000/3000-212/224/248

Table 25. SP Series AC Socket vs. Model

3-1-5-2. SP-3000/4000 AC output interface

Terminal (F)	Wire color	Wire length / gauge
AC terminal	Line (L)	Black
	Neutral (N)	White
FG (Ground)	Green / Yellow or Bare copper	200-240VAC: AWG10 100-120VAC: AWG8 26~32 feet / AWG# 10 ~ 8

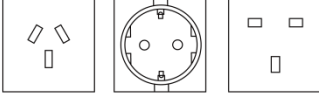
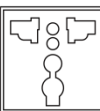
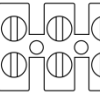
Table 26. SP-3000/4000 Series AC output wiring

3-1-5-3. GFCI connector

Recommend GFCI connector :

- HUBBELL INC WIRING DEVICE DIV, Type GF20 and GFRST20. Rated 125V, 20A
- COOPER WIRING DEVICES, Type VGF20 and SGF20. Rated 125V, 20A
- LEVITON MFG CO INC, Type 7899-W and GFNT2. Rated 125V, 20A
- PASS & SEYMOUR INC, Type 2097. Rated 125V, 20A

3-2. DC Input Side (Rear Panel) Introduction

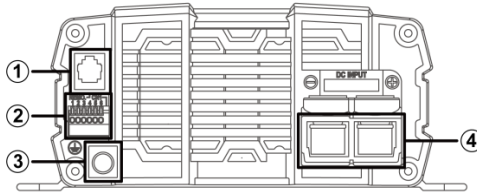

Figure 12. SP-700/1000

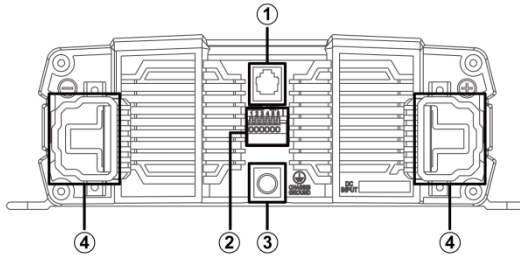

Figure 13. SP-1500/2000

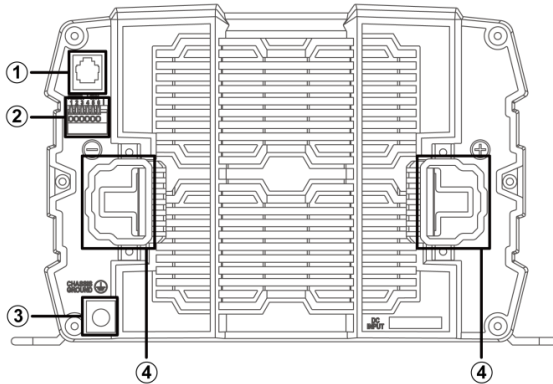

Figure 14. SP-3000/4000

Model	SP-700	SP-1000	SP-1500	SP-2000	SP-3000	SP-4000
①	Remote port (RJ-11)					
②	Remote control green terminal					
③	Chassis ground					
④	DC input connector					

Table 27. SP Series DC input side introduction

3-2-1. Remote Port (RJ-11)

The SP Series Inverter can be compatible with CR-8, and CR-16 remote control via RS-232 Communication.

Before using the remote control, make sure the main switch on inverter must be at “REMOTE” position.

Pin Number	Signal Description ①	
1	Reserved	--
2	GND	The same polarity as the battery negative side
3	RXD	RS-232 RXD
4	TXD	RS-232 TXD
5	RMT	Remote controller panel (positive)
6	VCC	Internal power for remote controller

Table 28. SP Series Remote Port : RJ-11

3-2-2. Remote Control Green Terminal

Remote control green terminal ② may be connected to a Form C relay for “FAULT” indication. When “FAULT” occurs, the relay switches.

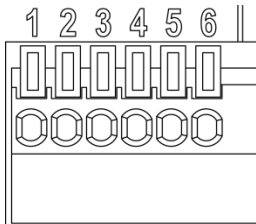

Figure 15. Remote control terminal

Item	Description	Item	Description
1	Dry contact (Normal Open)	4	Enable+ (ENB)
2	Common	5	Enable- ($\overline{\text{ENB}}$)
3	Dry contact (Normal Closed)	6	Ground

Table 29. Dry contact terminal definition



Note! Pin-6 is the same polarity with battery negative electrode.



Note! Fault conditions include Input under / over voltage, output short circuit / over load, over / under temperature.



Caution! Please follow the following steps for the installation

- Before installing the inverter, make sure the main switch is at “OFF” position.
- Before using the remote function, make sure the main switch pressed toward “REMOTE”
- Use 20 ~ 24 #AWG wire to connect the remote control terminals

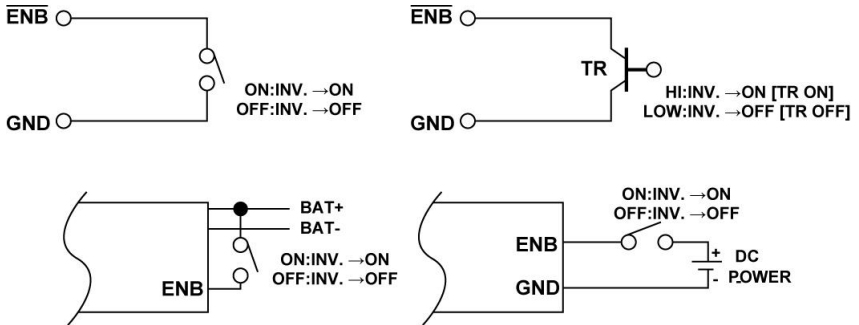

Figure 16. Wiring for control

3-2-3. General instruction before DC Input ④

3-2-3-1 Before installation:

The DC cables should be as short as possible (less than 6 feet / 1.8 meters ideally)

The size of the cable should be thick enough to limit the voltage drop to less than 2% when carrying the maximum input current to prevent frequent low-input voltage warnings, and shutdown.

The following sizes of cables and fuses are recommended distance (<6 ft.) between the batteries and the inverter.

Model	Wire AWG	Inline fuse
SP-700-112 / 212	#6	≥ 150A
SP-700-124 / 224	#10	≥ 80 A
SP-700-148 / 248	#16	≥ 50 A
SP-1000-112 / 212	#4	≥ 225A
SP-1000-124 / 224	#8	≥ 125A
SP-1000-148 / 248	#14	≥ 80A
SP-1500-112 / 212	#1	≥ 350A
SP-1500-124 / 224	#6	≥ 175A
SP-1500-148 / 248	#10	≥ 90A
SP-2000-112 / 212	#1/0	≥ 500A
SP-2000-124 / 224	#4	≥ 225A
SP-2000-148 / 248	#8	≥ 150A
SP-3000-112 / 212	#4/0	≥ 700A
SP-3000-124 / 224	#1	≥ 350A
SP-3000-148 / 248	#6	≥ 175A
SP-4000-124 / 224	#1/0	≥ 500A
SP-4000-148 / 248	#4	≥ 275A

Table 30. SP Series Wiring Cable diameter and Inline Fuse



Note! Batteries are capable of providing very large currents in case of short circuit. The fuse should be as close to the positive battery terminal as possible. Use Bussmann ANN series fuses (will also require Fuse Block 4164) or equivalent.

3-2-4. Chassis Ground ③

Must be connected to earth ground prior to making any other connections to the equipment.

3-3. Maintenance

Make sure that the fan vents are not blocked.

Use a vacuum cleaner to remove any dust from the fan area

When cleaning the case or front panel, use a soft, dry cloth, only. If the case or front panel is very dirty, use a neutral, non-abrasive detergent. Do not use alcohol or ammonia based solutions.

Regular service, and relocation of the inverter, should be performed by a qualified service technician. Avoid spilling liquid on the inverter.

4. Operation

4-1. Connection the DC cable

Connect DC input terminals to 12V / 24V /48V battery or other DC power source [+] is positive, [-] is negative. Reverse polarity connection can blow the internal fuse and may damage the inverter permanently.



Figure 17. DC cable connection



Warning! Make sure that all the DC connections are tight (torque to 9 – 10 ft-lbs, 11.7 – 13 Nm). Loose connections could result in overheating and can be a potential hazard.



Warning! The recommended inline fuse should be installed as close to the battery positive terminal as possible failure to use a fuse on the “+” cable running between the inverter and battery may cause damage to the cable / inverter and will void warranty.

Also, only use high quality copper wire and keep the cable length short which is a maximum of 3 - 6 feet.

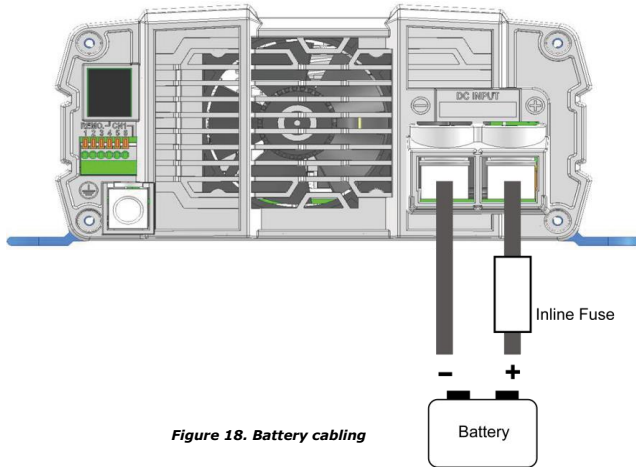

Figure 18. Battery cabling

4-2. Connecting the input power

Before making the DC input side connections ④, the main switch ⑤ must be at “OFF”.

4-3. Connecting the loads

Calculate the total power consumption of the output load. Make sure that the total power consumption does not exceed the rated power.

If the total power consumption over the rated power of the inverter, remove the non-critical: loads until the total power consumption is below the rated power.

4-4. Switch ON Inverter

Set the power switch to the “ON” position ⑤. The inverter will carry out self-diagnosis and, the LED’s will also appear various colors.

Set the power switch to the “OFF” position ⑤. The inverter stops and all the lights that are on will go off.

4-5. Protection Mechanism

Model	Over Voltage (DC)		Under Voltage	Under Voltage	
	Shutdown	Restart	Alarm	Shutdown	Restart
12V	16.5V ± 0.3V	14.5V± 0.3V	10.5V ± 0.3V	10.5V ± 0.3V	12.5V± 0.3V
24V	33V ± 0.5V	29V ± 0.5V	21V± 0.5V	21V ± 0.5V	25V ± 0.5V
48V	66 ± 1V	58V ± 1V	42V± 1V	42V ± 1V	50 ± 1V

Table 31. Protection Mechanism

Model	Over temperature protection	
	Shutdown	Restart
12V	80°C	60°C
24V		
48V		

Table 32. Over Temperature Protection Mechanism

5. RS-232 Communication and Operation

5-1. RS-232 Port

RS-232 Port : Serial port monitoring and control through computer interface.

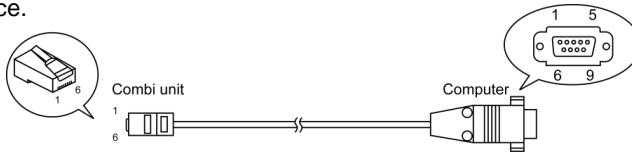

Figure 19. RS-232 cable

SP Series		Computer	
PIN Number	Description	PIN Number	Description
1	Not used	1	Not used
2	GND	2	RXD
3	RXD	3	TXD
4	TXD	4	Not used
5	Remo Control	5	GND
6	VCC	6	Not used
		7	Not used
		8	Not used
		9	Not used

Table 33. RS-232 interface definition

5-2. RS-232 Port Operating

The following steps show the connection among inverter and computer.

- Step 1 Connect the RS-232 port to the SP series unit on the front panel
- Step 2 Run the computer communication program
- Step 3 Set the transmission protocol
 Byte structure: START-BIP – 8 BIT DATA-STOP BIT
 Baud rate: 4800
- Step 4 Select the COM port and start the operation

5-3. Example of RS-232 Port Operating

5-3-1. RS-232 command format

This unit uses high-level language commands starts with CR (0DH) and LF(0AH) as the end of the command, The system would interpret and execute the command only after these two characters are received. After the unit executes the command, it would send a response string to the computer

The response string is as follows:

- => CR LF: Command executed successfully
- ?> CR LF: Command error, not accepted
- !> CR LF: Command correct but execution error (e.g. parameters out of range)

5-3-2. Command format

The following table shows the useful command to operate SP series.

Function	Command and description
Turn ON / OFF SP series	Format : Power <value> <value> can be one of the following. "0" : Power OFF "1" : Power ON
Query the SP series output frequency	Format: FRQ?
Query the SP series output voltage	Format: VINV?
Query the SP series output current	Format: IINV?

Function	Command and description																						
<p>Query the SP series status</p>	<p>Format: ERR? (SP-700~2000)</p> <table border="1" data-bbox="566 240 1000 815"> <thead> <tr> <th>Bit</th> <th>Description</th> </tr> </thead> <tbody> <tr> <td>BIT0</td> <td>0: No OLPL Protection 1: OLPL Protection</td> </tr> <tr> <td>BIT1</td> <td>0:No Sof Fail Protection 1:SofFail Protection</td> </tr> <tr> <td>BIT2</td> <td>0:No Poff Protection 1:Poff Protection</td> </tr> <tr> <td>BIT3</td> <td>0:No UVP Protection 1:UVP Protection</td> </tr> <tr> <td>BIT4</td> <td>0:No OVP Protection 1:OVP Protection</td> </tr> <tr> <td>BIT5</td> <td>0:No OLPM Protection 1: OLPM Protection</td> </tr> <tr> <td>BIT6</td> <td>0:No OLPH Protection 1: OLPH Protection</td> </tr> <tr> <td>BIT7</td> <td>0:No OTP Protection 1: OTP Protection</td> </tr> <tr> <td>BIT8</td> <td>0:No UTP Protection 1: UTP Protection</td> </tr> <tr> <td>BIT9</td> <td>0:No OOC Protection 1: OOC Protection</td> </tr> </tbody> </table>	Bit	Description	BIT0	0: No OLPL Protection 1: OLPL Protection	BIT1	0:No Sof Fail Protection 1:SofFail Protection	BIT2	0:No Poff Protection 1:Poff Protection	BIT3	0:No UVP Protection 1:UVP Protection	BIT4	0:No OVP Protection 1:OVP Protection	BIT5	0:No OLPM Protection 1: OLPM Protection	BIT6	0:No OLPH Protection 1: OLPH Protection	BIT7	0:No OTP Protection 1: OTP Protection	BIT8	0:No UTP Protection 1: UTP Protection	BIT9	0:No OOC Protection 1: OOC Protection
	Bit	Description																					
BIT0	0: No OLPL Protection 1: OLPL Protection																						
BIT1	0:No Sof Fail Protection 1:SofFail Protection																						
BIT2	0:No Poff Protection 1:Poff Protection																						
BIT3	0:No UVP Protection 1:UVP Protection																						
BIT4	0:No OVP Protection 1:OVP Protection																						
BIT5	0:No OLPM Protection 1: OLPM Protection																						
BIT6	0:No OLPH Protection 1: OLPH Protection																						
BIT7	0:No OTP Protection 1: OTP Protection																						
BIT8	0:No UTP Protection 1: UTP Protection																						
BIT9	0:No OOC Protection 1: OOC Protection																						
<p>* Status definition refer to Table 35. Status definition</p> <p>Format: ERR? (SP-3000~4000)</p> <table border="1" data-bbox="566 900 1000 1444"> <thead> <tr> <th>Bit</th> <th>Description</th> </tr> </thead> <tbody> <tr> <td>BIT0</td> <td>0: No ID Fail 1: ID Fail</td> </tr> <tr> <td>BIT1</td> <td>0:No Sof Fail Protection 1:SofFail Protection</td> </tr> <tr> <td>BIT2</td> <td>0:No PLL Fail 1:PLL Fail</td> </tr> <tr> <td>BIT3</td> <td>0:No Poff Protection 1:Poff Protection</td> </tr> <tr> <td>BIT4</td> <td>0:No Short Protection 1:Short Protection</td> </tr> <tr> <td>BIT5</td> <td>0:No OOC Protection 1: OOC Protection</td> </tr> <tr> <td>BIT6</td> <td>0:NoOVP Protection 1:OVP Protection</td> </tr> <tr> <td>BIT7</td> <td>0:No UVP Protection 1:UVP Protection</td> </tr> <tr> <td>BIT8</td> <td>0:No OTP Protection 1: OTP Protection</td> </tr> </tbody> </table>	Bit	Description	BIT0	0: No ID Fail 1: ID Fail	BIT1	0:No Sof Fail Protection 1:SofFail Protection	BIT2	0:No PLL Fail 1:PLL Fail	BIT3	0:No Poff Protection 1:Poff Protection	BIT4	0:No Short Protection 1:Short Protection	BIT5	0:No OOC Protection 1: OOC Protection	BIT6	0:NoOVP Protection 1:OVP Protection	BIT7	0:No UVP Protection 1:UVP Protection	BIT8	0:No OTP Protection 1: OTP Protection			
Bit	Description																						
BIT0	0: No ID Fail 1: ID Fail																						
BIT1	0:No Sof Fail Protection 1:SofFail Protection																						
BIT2	0:No PLL Fail 1:PLL Fail																						
BIT3	0:No Poff Protection 1:Poff Protection																						
BIT4	0:No Short Protection 1:Short Protection																						
BIT5	0:No OOC Protection 1: OOC Protection																						
BIT6	0:NoOVP Protection 1:OVP Protection																						
BIT7	0:No UVP Protection 1:UVP Protection																						
BIT8	0:No OTP Protection 1: OTP Protection																						

Function	Command and description														
	<table border="1"> <tr> <td>BIT9</td> <td>0:No UTP Protection 1: UTP Protection</td> </tr> <tr> <td>BIT10</td> <td>0:No OLPH Protection 1: OLPH Protection</td> </tr> <tr> <td>BIT11</td> <td>0:No OLPL Protection 1: OLPL Protection</td> </tr> </table> <p>* Status definition refer to Table 36. Status definition</p>	BIT9	0:No UTP Protection 1: UTP Protection	BIT10	0:No OLPH Protection 1: OLPH Protection	BIT11	0:No OLPL Protection 1: OLPL Protection								
BIT9	0:No UTP Protection 1: UTP Protection														
BIT10	0:No OLPH Protection 1: OLPH Protection														
BIT11	0:No OLPL Protection 1: OLPL Protection														
Query the SP series DC input voltage of the battery	Format: VBAT?														
Query the SP series output power	Format: PINV?														
Reset default	Format:*RST														
Select the Setup Menus with the help of Function Codes	Format : FUNC <Function Code> <table border="1"> <thead> <tr> <th>Function code</th> <th>Setting Menu</th> </tr> </thead> <tbody> <tr> <td>0</td> <td>OVP setting</td> </tr> <tr> <td>1</td> <td>OVP Recovery</td> </tr> <tr> <td>2</td> <td>UVP Setting</td> </tr> <tr> <td>3</td> <td>UVP Recovery</td> </tr> <tr> <td>5</td> <td>RS-232 Baud-rate</td> </tr> <tr> <td>6</td> <td>Retry Time</td> </tr> </tbody> </table>	Function code	Setting Menu	0	OVP setting	1	OVP Recovery	2	UVP Setting	3	UVP Recovery	5	RS-232 Baud-rate	6	Retry Time
Function code	Setting Menu														
0	OVP setting														
1	OVP Recovery														
2	UVP Setting														
3	UVP Recovery														
5	RS-232 Baud-rate														
6	Retry Time														
Query the functions No	Format: FUNC?														
Query the setting value of the function	Format: SETT?														
Set or adjust the value of the function	Format: SETT <value>														

Table 34. RS-232 interface command

SP-700 ~ SP-2000 Status Definition

Description	Definition
OLPL Protection	OLPL: Over Load Protection Low (101~115%)
Sof Fail Protection	Sof Fail: Soft Start Fail
Poff Protection	Poff: Power off
UVP Protection	UVP: Under Voltage Protection
OVP Protection	OVP: Over Voltage Protection
OLPM Protection	OLPM: Over Load Protection Middle (116~200%)
OLPH Protection	OLPH: Over Load Protection High (>200%)
OTP Protection	OTP: Over Temperature Protection
UTP Protection	UTP: Under Temperature Protection
OOC Protection	OOC: Output Over Current Protection

Table 35. SP-700 ~ SP-2000 Status Definition

SP-3000 ~ SP-4000 Status Definition

Description	Definition
ID	ID: ID Connection Error
Sof Fail Protection	Sof Fail: Soft Start Fail
PLL	PLL: Phase lock loop
Poff Protection	Poff: Power off
OOC Protection	OOC: Output Over Current Protection (Over Load > 200%)
OVP Protection	OVP: Over Voltage Protection
UVP Protection	UVP: Under Voltage Protection
OTP Protection	OTP: Over Temperature Protection
UTP Protection	UTP: Under Temperature Protection
OLPH Protection	OLPH: Over Load Protection High (116~200%)
OLPL Protection	OLPL: Over Load Protection Low (101~115%)

Table 36. SP-3000 ~ SP-4000 Status Definition

The following data shows the function code detail setting value.

**Note:**

Below setting value will go back to default value by switching on / off the inverter.

5-3-2-1. FUNC 0 : OVP setting

SETT <value>	Default	Model
15.0 ~ 16.5	16.5V <16.5>	SP series-112 / 212
30.0 ~ 33.0	33.0V <33.0>	SP series-124 / 224
60.0 ~ 66.0	66.0V <66.0>	SP series-148 / 248

Table 37. OVP setting

5-3-2-2. FUNC 1 : OVP Recovery

SETT <value>	Default	Model
13.5 ~ 14.5	14.5V <14.5>	SP series-112 / 212
27.0 ~ 29.0	29.0V <29.0>	SP series-124 / 224
54.0 ~ 58.0	58.0V <58.0>	SP series-148 / 248

Table 38. OVP recovery

5-3-2-3. FUNC 2 : UVP setting

SETT <value>	Default	Model
10.5 ~ 11.5	10.5V <10.5>	SP series-112 / 212
21.0 ~ 23.0	21.0V <21.0>	SP series-124 / 224
42.0 ~ 46.0	42.0V <42.0>	SP series-148 / 248

Table 39. UVP setting

5-3-2-4. FUNC 3 : UVP Recovery

SETT <value>	Default	Model
12.5 ~ 13.5	12.5V <12.5>	SP series-112 / 212
25.0 ~ 27.0	25.0V <25.0>	SP series-124 / 224
50.0 ~ 54.0	50.0V <50.0>	SP series-148 / 248

Table 40. UVP recovery

5-3-2-5. FUNC 5 : RS-232 Baud rate

SETT <value>	Default	Model
0	2	1200
1		2400
2		4800
3		9600

Table 41. RS-232 baud rate

5-3-2-6. FUNC 6 : Retry time

SETT <value>	Default
0	3
1	
2	
3	

Table 42. retry time

6. Information

6-1. Warning



Warning! Do not open or disassemble the Inverter. Attempting to do so may cause risk of electrical shock or fire.

6-2. Warranty

We guarantee this product against defects in materials and workmanship for a period of 24 months from the date of purchase. In case you need to repair or replace any defective power inverters, please contact COTEK local distributor.

This warranty will be considered void if the unit has been misused, altered, or accidentally damaged. COTEK is not liable for anything that occurs as a result of the user's fault.

Table des matières

1. CONSIGNES DE SÉCURITÉ	41
1-1. Consignes d'ordre general	41
1-2. Précautions	42
2. CARACTÉRISTIQUES FONCTIONNELLES	43
2-1. Système	43
2-2. Schéma de principe	43
2-3. Caractéristique électriques	44
2-3-1. Modèles SP-700	44
2-3-2. Modèles SP-1000	46
2-3-3. Modèles SP-1500	48
2-3-4. Modèles SP-2000	50
2-3-5. SP-3000 Specification	51
2-3-6. SP-4000 Specification	53
2-3-7. Schémas de performances	55
2-4. Dessins techniques	57
3. INSTALLATION ET MAINTENANCE	58
3-1. Présentation du panneau avant (côté sortie CA)	58
3-1-1. Interrupteur	59
3-1-2. Indicateur à LEDs	59
3-1-3. Introduction aux interrupteurs DIP	60
3-1-4. Socle relais de transfert TRC	62
3-1-5. Interfaces de sortie CA	63

3-2. Présentation du panneau arrière (côté entrée CC)	64
3-2-1. Socle RJ-11	65
3-2-2. Bornier de la commande déportée (bornier vert)	65
3-2-3. Consignes générales – Entrée CC	66
3-2-4. Liaison à la masse	67
3-3. Entretien	67
4. UTILISATION DE L'ONDULEUR	68
4-1. Bornes d'entrée courant continu	68
4-2. Connexions courant continu	69
4-3. Connexions courant alternatif (consommateurs)	69
4-4. Marche / Arrêt de l'onduleur	69
4-5. Protections	69
5. PORT DE COMMUNICATION RS-232	70
5-1. Caractéristiques	70
5-2. Procédure d'utilisation	70
5-3. Mode de fonctionnement du port RS-232	70
5-3-1. Format des commandes RS-232	70
5-3-2. Commandes utiles	71
6. GARANTIE	75
6-1. Avertissement	75
6-2. Garantie	75

1. Consignes de sécurité

1-1. Consignes d'ordre general



Attention!

Prendre le temps de lire les consignes de sécurité avant d'utiliser l'onduleur.

- Ne pas exposer l'onduleur à la pluie, à la neige, aux projections d'eau ou à la poussière. Pour réduire les risques électriques (incendie) ne pas couvrir ni obstruer les grilles de ventilation. Ne pas installer l'onduleur dans un compartiment non aéré au risque de provoquer une surchauffe.
- Pour éviter les risques d'incendie et de chocs électriques, s'assurer que les câbles de branchement soient en bon état et d'une section suffisante.
- Certains composants de l'onduleur peuvent provoquer des arcs électriques ou des étincelles. Pour éviter les risques d'incendie ou d'explosion, l'onduleur ne doit pas être installé à proximité des batteries ou de matériaux inflammables ni dans un local qui requiert une protection anti-déflagration. Cette précaution s'étend aux locaux des machines à essence, des réservoirs à carburant ou de leurs conduites.
- En fonction de l'application, l'utilisateur peut être amené à monter une protection (fusible ou disjoncteur) sur la sortie CA de l'onduleur. Les câbles et connecteurs ne sont pas fournis pour ce branchement. L'onduleur est équipé de série d'une protection interne contre les court-circuit (CA).
- Prendre les précautions suivantes en cas d'intervention sur l'onduleur :
 - ✧ Ne porter aucun bijou (montre, bague) ou autre accessoire métallique.
 - ✧ Utiliser des outils isolés.
 - ✧ Utiliser des gants de protection et des chaussures en caoutchouc.
- Ouvrir ou démonter l'onduleur entraîne une annulation de la garantie.

1-2. Précautions

- À réception, vérifier l'état de l'emballage. S'il est endommagé, en informer votre distributeur.
- Ne pas utiliser l'onduleur à proximité d'une source en eau ou dans un environnement excessivement humide.
- Bien serrer les branchements CC.
- La liaison à la masse doit être fiable et permanente.
- Ne pas laisser tomber d'objets métalliques sur la batterie. L'étincelle ou le court-circuit en résultant pourrait provoquer une explosion.
- Installer l'onduleur dans un lieu correctement ventilé. Ne pas obstruer les grilles de ventilation sur l'avant (prise d'air frais) et sur l'arrière (sortie air chaud).
- L'onduleur doit disposer d'une alimentation adéquate. S'assurer que la section des câbles soit suffisante.
- Poser l'onduleur de manière à ce que l'axe du ventilateur soit horizontal.
- Ne pas utiliser l'onduleur à proximité d'une source de carburant ou d'un feu ouvert.
- Ne pas raccorder de consommateurs susceptibles de créer des retours de courant à l'onduleur.
- Pour des performances optimales, veiller à respecter la plage de températures admissibles : -20°C à +40°C (températures ambiantes). Le flux de l'air ne doit jamais être entravé.

2. Caractéristiques fonctionnelles

2-1. Système

Le SP est un onduleur CC-CA de grande fiabilité, à base de composants électroniques et microprocesseurs dernière génération. Ils offrent les caractéristiques suivantes :

- Signal de sortie sinusoïdal pur 1xx : DHT < 5%, 2xx : DHT < 3%
- Relais de transfert en option (TR-40).
- Gestion d'énergie par algorithmes.
- Ventilateur de refroidissement asservi à la charge et à la température.
- Compatible avec les commandes CR-8 / CR-16.
- Port de communication RS-232.
- Bornes à contact sec.
- Protection étendue :
 - ✧ tension haute / tension basse.
 - ✧ surchauffe.
 - ✧ inversion de polarité (fusible).
 - ✧ surcharge.
 - ✧ court-circuit.

2-2. Schéma de principe



2-3. Caractéristique électriques

2-3-1. Modèles SP-700

		SP-700-112	SP-700-124	SP-700-148
Entrée	Tension d'alimentation	12VDC	24VDC	48VDC
	Protection tension haute ^①	16,5 ± 0,3VDC	33 ± 0,5VDC	66 ± 1,0VDC
	Protection tension basse	10,5 ± 0,3VDC	21 ± 0,5VDC	42 ± 1,0VDC
	Plage de tensions admissibles	10,5 à 16,5VDC	21 à 33VDC	42 à 66VDC
	Courant à vide	≤ 1,5A @12VDC	≤ 0,8A @24VDC	≤ 0,5A @48VDC
	Consommation en Standby	<0,1A @12VDC	<0,06A @24VDC	<0,05A @48VDC
Sortie	Puissance nominale	700 VA (± 3%)		
	Puissance nominale max. (1 min.)	> 700 VA~810 VA (100%~115%)		
	Puissance crête (max.3 s.)	< 1230 VA		
	Fréquence	50 / 60 Hz ± 0,5% (sélection par interrupteurs DIP)		
	Tension de sortie	100 / 110 / 115 / 120 V CA (± 5%) (sélection par interrupteurs DIP)		
	Rendement max.	91%	93%	93%
	Protection court-circuit	Temporisation d'une seconde		
Signal de sortie ^②	Sinusoïdal pur (DHT < 5 %)			
Signal & contrôles	Commande déportée	CR-8 / CR-16 (en option)		
	Témoins	LEDs (rouge / orange / verte)		
	Borne à contact sec	Via un relais		
	Bornier de commande déportée	Bornier 6 broches vert (commandes Marche / Arrêt)		
Protections	Tension d'alimentation	Tension haute, tension basse, inversion de polarité (fusible interne)		
	Protections sortie CA	Court-circuit, surcharge		
	Autres protections	Température haute / basse (dissipateur + 80°C / - 20°C)		
Environnement	Plage admissible, température ambiante ^③	- 20 °C à + 40 °C		
	Plage admissible, température de stockage	- 30 °C à + 70 °C		
	Plage admissible, humidité de stockage	10 à 95 % (taux d'humidité relative)		
Normes	Sécurité	UL 458 (avec socle GFCl uniquement)		----
	CEM	FCC classe B		
	E-mark	----		
Cotes (largeur x hauteur x profondeur)		200mm X 83mm X 330mm		
Poids		2.6 KG		
Refroidissement		Ventilateur asservi à la charge et à la température		
Relais de transfert		En option : TR-40		

Tableau 1 – modèles SP-700 pour sorties 100 / 110 / 115 / 120 V CA



① Voir schéma 1

② Tension d'entrée : 12,5 V / 25 V / 50 V – Tension de sortie : 100 / 110 / 115 / 120 V CA
80 % de la puissance nominale (facteur de puissance = 1.0)

③ Voir schéma 2

		SP-700-212	SP-700-224	SP-700-248
Entrée	Tension d'alimentation	12VDC	24VDC	48VDC
	Protection tension haute ^①	16,5 ± 0,3VDC	33 ± 0,5VDC	66 ± 1,0VDC
	Protection tension basse	10,5 ± 0,3VDC	21 ± 0,5VDC	42 ± 1,0VDC
	Plage de tensions admissibles	10,5 à 16,5VDC	21 à 33VDC	42 à 66VDC
	Courant à vide	≤ 1,5A @12VDC	≤ 0,8A @24VDC	≤ 0,5A @48VDC
	Consommation en Standby	<0,1A @12VDC	<0,06A @24VDC	<0,05A @48VDC
Sortie	Puissance nominale	700 VA (± 3%)		
	Puissance nominale max. (1 min.)	> 700 VA~810 VA (100%~115%)		
	Puissance crête (max.3 s.)	< 1230 VA		
	Fréquence	50 / 60 Hz ± 0.5% (sélection par interrupteurs DIP)		
	Tension de sortie	200 / 220 / 230 / 240 V CA (± 3%) (sélection par interrupteurs DIP)		
	Rendement max.	91%	93%	94%
	Protection court-circuit	Temporisation d'une seconde		
	Signal de sortie ^②	Sinusoïdal pur (DHT < 3 %)		
Signal & contrôles	Commande déportée	CR-8 / CR-16 (en option)		
	Témoins	LEDs (rouge / orange / verte)		
	Borne à contact sec	Via un relais		
	Bornier de commande déportée	Bornier 6 broches vert (commandes Marche / Arrêt)		
Protections	Tension d'alimentation	Tension haute, tension basse, inversion de polarité (fusible interne)		
	Protections sortie CA	Court-circuit, surcharge		
	Autres protections	Température haute / basse (dissipateur + 80°C / - 20°C)		
Environnement	Plage admissible, température ambiante ^③	- 20 °C à + 40 °C		
	Plage admissible, température de stockage	- 30 °C à + 70 °C		
	Plage admissible, humidité de stockage	10 à 95 % (taux d'humidité relative)		
Normes	Sécurité	EN 60950-1		
	CEM	EN 55022 class B; EN 55024; EN 61000-3-2, -3-3 EN 61000-4-2, 3, 4, 5, 6, 8, 11		
	E-mark	CISPR 25; ISO 7637-2		
Cotes (largeur x hauteur x profondeur)		200mm X 83mm X 330mm		
Poids		2.6 KG		
Refroidissement		Ventilateur asservi à la charge et à la température		
Relais de transfert		En option : TR-40		

Tableau 2. SP-700 for Output 200/220/230/240 VAC Specification.

① Voir schéma 1

② Tension d'entrée : 12,5 V / 25 V / 50 V – Tension de sortie : 200 / 220 / 230 / 240 V CA
80 % de la puissance nominale (facteur de puissance = 1.0)

③ Voir schéma 2

2-3-2. Modèles SP-1000

		SP-1000-112	SP-1000-124	SP-1000-148
Entrée	Tension d'alimentation	12VDC	24VDC	48VDC
	Protection tension haute ^①	16,5 ± 0,3VDC	33 ± 0,5VDC	66 ± 1,0VDC
	Protection tension basse	10,5 ± 0,3VDC	21 ± 0,5VDC	42 ± 1,0VDC
	Plage de tensions admissibles	10,5 à 16,5VDC	21 à 33VDC	42 à 66VDC
	Courant à vide	≤ 1,5A @12VDC	≤ 0,8A @24VDC	≤ 0,5A @48VDC
	Consommation en Standby	<0,1A @12VDC	<0,06A @24VDC	<0,05A @48VDC
Sortie	Puissance nominale	1000 VA (± 3%)		
	Puissance nominale max. (1 min.)	> 1000 VA~1150 VA (100%~115%)		
	Puissance crête (max.3 s.)	< 1750 VA		
	Fréquence	50 / 60 Hz ± 0.5% (sélection par interrupteurs DIP)		
	Tension de sortie	100 / 110 / 115 / 120 VAC (± 5%) (sélection par interrupteurs DIP)		
	Rendement max.	92%	93%	93%
	Protection court-circuit	Temporisation d'une seconde		
Signal de sortie ^②	Sinusoïdal pur (DHT < 5 %)			
Signal & contrôles	Commande déportée	CR-8 / CR-16 (en option)		
	Témoins	LEDs (rouge / orange / verte)		
	Borne à contact sec	Via un relais		
	Bornier de commande déportée	Bornier 6 broches vert (commandes Marche / Arrêt)		
Protections	Tension d'alimentation	Tension haute, tension basse, inversion de polarité (fusible interne)		
	Protections sortie CA	Court-circuit, surcharge		
	Autres protections	Température haute / basse (dissipateur + 80°C / - 20°C)		
Environnement	Plage admissible, température ambiante ^③	- 20 °C à + 40 °C		
	Plage admissible, température de stockage	- 30 °C à + 70 °C		
	Plage admissible, humidité de stockage	10 à 95 % (taux d'humidité relative)		
Normes	Sécurité	UL 458 (avec socle GFCI uniquement)		----
	CEM	FCC classe B		
	E-mark	----		
Cotes (largeur x hauteur x profondeur)		200mm X 83mm X 372mm		
Poids		3.26 KG		
Refroidissement		Ventilateur asservi à la charge et à la température		
Relais de transfert		En option : TR-40		

Tableau 3 – modèles SP-1000 pour sorties 100 / 110 / 115 / 120 V CA



① Voir schéma 1

② Tension d'entrée : 12,5 V / 25 V / 50 V – Tension de sortie : 100 / 110 / 115 / 120 V CA
80 % de la puissance nominale (facteur de puissance = 1.0)

③ Voir schéma 2

		SP-1000-212	SP-1000-224	SP-1000-248
Entrée	Tension d'alimentation	12VDC	24VDC	48VDC
	Protection tension haute ^①	16,5 ± 0,3VDC	33 ± 0,5VDC	66 ± 1,0VDC
	Protection tension basse	10,5 ± 0,3VDC	21 ± 0,5VDC	42 ± 1,0VDC
	Plage de tensions admissibles	10,5 à 16,5VDC	21 à 33VDC	42 à 66VDC
	Courant à vide	≤ 1,5A @12VDC	≤ 0,8A @24VDC	≤ 0,4A @48VDC
	Consommation en Standby	< 0,1A @12VDC	<0,05A @24VDC	<0,05A @48VDC
Sortie	Puissance nominale	1000 VA (± 3%)		
	Puissance nominale max. (1 min.)	> 1000 VA~1150 VA (100%~115%)		
	Puissance crête (max.3 s.)	< 1750 VA		
	Fréquence	50 / 60 Hz ± 0.5% (sélection par interrupteurs DIP)		
	Tension de sortie	200 / 220 / 230 / 240 VAC (± 3%) (sélection par interrupteurs DIP)		
	Rendement max.	92%	94%	94%
	Protection court-circuit	Temporisation d'une seconde		
Signal de sortie ^②	Sinusoïdal pur (DHT < 3 %)			
Signal & contrôles	Commande déportée	CR-8 / CR-16 (en option)		
	Témoins	LEDs (rouge / orange / verte)		
	Borne à contact sec	Via un relais		
	Bornier de commande déportée	Bornier 6 broches vert (commandes Marche / Arrêt)		
Protections	Tension d'alimentation	Tension haute, tension basse, inversion de polarité (fusible interne)		
	Protections sortie CA	Court-circuit, surcharge		
	Autres protections	Température haute / basse (dissipateur + 80°C / - 20°C)		
Environnement	Plage admissible, température ambiante ^③	- 20 °C à + 40 °C		
	Plage admissible, température de stockage	- 30 °C à + 70 °C		
	Plage admissible, humidité de stockage	10 à 95 % (taux d'humidité relative)		
Normes	Sécurité	EN 60950-1		
	CEM	EN 55022 class B; EN 55024; EN 61000-3-2, -3-3 EN 61000-4-2, 3, 4, 5, 6, 8, 11		
	E-mark	CISPR 25; ISO 7637-2		
Cotes (largeur x hauteur x profondeur)		200mm X 83mm X 372mm		
Poids		3.26 KG		
Refroidissement		Ventilateur asservi à la charge et à la température		
Relais de transfert		En option : TR-40		

Tableau 4 – modèles SP-1000 pour sorties 200 / 220 / 230 / 240 V CA



① Voir schéma 1

② Tension d'entrée : 12,5 V / 25 V / 50 V – Tension de sortie : 200 / 220 / 230 / 240 V CA
80 % de la puissance nominale (facteur de puissance = 1.0)

③ Voir schéma 2

2-3-3. Modèles SP-1500

		SP-1500-112	SP-1500-124	SP-1500-148
Entrée	Tension d'alimentation	12VDC	24VDC	48VDC
	Protection tension haute ^①	16,5 ± 0,3VDC	33 ± 0,5VDC	66 ± 1,0VDC
	Protection tension basse	10,5 ± 0,3VDC	21 ± 0,5VDC	42 ± 1,0VDC
	Plage de tensions admissibles	10,5 à 16,5VDC	21 à 33VDC	42 à 66VDC
	Courant à vide	≤ 1,8A @12VDC	≤ 1,0A @24VDC	≤ 0,5A @48VDC
	Consommation en Standby	<0,1A @12VDC	<0,05A @24VDC	<0,05A @48VDC
Sortie	Puissance nominale	1500 VA (± 3%)		
	Puissance nominale max. (1 min.)	> 1500 VA~1730VA (100%~115%)		
	Puissance crête (max.3 s.)	<2650 VA		
	Fréquence	50 / 60 Hz ± 0.5% (sélection par interrupteurs DIP)		
	Tension de sortie	100 / 110 / 115 / 120 VAC (± 5%) (sélection par interrupteurs DIP)		
	Rendement max.	91%	92%	93%
	Protection court-circuit	Temporisation d'une seconde		
Signal de sortie ^②	Sinusoïdal pur (DHT < 5 %)			
Signal & contrôles	Commande déportée	CR-8 / CR-16 (en option)		
	Témoins	LEDs (rouge / orange / verte)		
	Borne à contact sec	Via un relais		
	Bornier de commande déportée	Bornier 6 broches vert (commandes Marche / Arrêt)		
Protections	Tension d'alimentation	Tension haute, tension basse, inversion de polarité (fusible interne)		
	Protections sortie CA	Court-circuit, surcharge		
	Autres protections	Température haute / basse (dissipateur + 80°C / - 20°C)		
Environnement	Plage admissible, température ambiante ^③	- 20 °C à + 40 °C		
	Plage admissible, température de stockage	- 30 °C à + 70 °C		
	Plage admissible, humidité de stockage	10 à 95 % (taux d'humidité relative)		
Normes	Sécurité	UL 458 (avec socle GFCI uniquement)		----
	CEM	FCC classe B		
	E-mark	----		
Cotes (largeur x hauteur x profondeur)		248mm X 83mm X 421mm		
Poids		4.14 KG		
Refroidissement		Ventilateur asservi à la charge et à la température		
Relais de transfert		En option : TR-40		

Tableau 5 – modèles SP-1500 pour sorties 100 / 110 / 115 / 120 V CA



① Voir schéma 1

② Tension d'entrée : 12,5 V / 25 V / 50 V – Tension de sortie : 100 / 110 / 115 / 120 V CA
80 % de la puissance nominale (facteur de puissance = 1.0)

③ Voir schéma 2

		SP-1500-212	SP-1500-224	SP-1500-248
Entrée	Tension d'alimentation	12VDC	24VDC	48VDC
	Protection tension haute ^①	16,5 ± 0,3VDC	33 ± 0,5VDC	66 ± 1,0VDC
	Protection tension basse	10,5 ± 0,3VDC	21 ± 0,5VDC	42 ± 1,0VDC
	Plage de tensions admissibles	10,5 à 16,5VDC	21 à 33VDC	42 à 66VDC
	Courant à vide	≤ 1,8A @12VDC	≤ 1,0A @24VDC	≤ 0,5A @48VDC
	Consommation en Standby	<0,1A @12VDC	<0,05A @24VDC	<0,05A @48VDC
Sortie	Puissance nominale	1500 VA (± 3%)		
	Puissance nominale max. (1 min.)	> 1500 VA~1730VA (100%~115%)		
	Puissance crête (max.3 s.)	<2650 VA		
	Fréquence	50 / 60 Hz ± 0.5% (sélection par interrupteurs DIP)		
	Tension de sortie	200 / 220 / 230 / 240 VAC (± 3%) (sélection par interrupteurs DIP)		
	Rendement max.	93%	94%	94%
	Protection court-circuit	Temporisation d'une seconde		
Signal de sortie ^②	Sinusoïdal pur (DHT < 3 %)			
Signal & contrôles	Commande déportée	CR-8 / CR-16 (en option)		
	Témoins	LEDs (rouge / orange / verte)		
	Borne à contact sec	Via un relais		
	Bornier de commande déportée	Bornier 6 broches vert (commandes Marche / Arrêt)		
Protections	Tension d'alimentation	Tension haute, tension basse, inversion de polarité (fusible interne)		
	Protections sortie CA	Court-circuit, surcharge		
	Autres protections	Température haute / basse (dissipateur + 80°C / - 20°C)		
Environnement	Plage admissible, température ambiante ^③	- 20 °C à + 40 °C		
	Plage admissible, température de stockage	- 30 °C à + 70 °C		
	Plage admissible, humidité de stockage	10 à 95 % (taux d'humidité relative)		
Normes	Sécurité	EN 60950-1		
	CEM	EN 55022 class B; EN 55024; EN 61000-3-2, -3-3 EN 61000-4-2, 3, 4, 5, 6, 8, 11		
	E-mark	CISPR 25; ISO 7637-2		
Cotes (largeur x hauteur x profondeur)		248mm X 83mm X 421mm		
Poids		4.14 KG		
Refroidissement		Ventilateur asservi à la charge et à la température		
Relais de transfert		En option : TR-40		

Tableau 6 – modèles SP-1500 pour sorties 200 / 220 / 230 / 240 V CA



① Voir schéma 1

② Tension d'entrée : 12,5 V / 25 V / 50 V – Tension de sortie : 200 / 220 / 230 / 240 V CA
80 % de la puissance nominale (facteur de puissance = 1.0)

③ Voir schéma 2

2-3-4. Modèles SP-2000

		SP-2000-112	SP-2000-124	SP-2000-148
Entrée	Tension d'alimentation	12VDC	24VDC	48VDC
	Protection tension haute ^①	16,5 ± 0,3VDC	33 ± 0,5VDC	66 ± 1,0VDC
	Protection tension basse	10,5 ± 0,3VDC	21 ± 0,5VDC	42 ± 1,0VDC
	Plage de tensions admissibles	10,5 à 16,5VDC	21 à 33VDC	42 à 66VDC
	Courant à vide	≤ 1,8A @ 12VDC	≤ 1,0A @ 24VDC	≤ 0,5A @ 48VDC
	Consommation en Standby	< 0,1A @ 12VDC	< 0,05A @ 24VDC	< 0,05A @ 48VDC
Sortie	Puissance nominale	2000 VA (± 3%)		
	Puissance nominale max. (1 min.)	> 2000 VA~2300 VA (100%~115%)		
	Puissance crête (max.3 s.)	< 3500 VA		
	Fréquence	50 / 60 Hz ± 0.5% (sélection par interrupteurs DIP)		
	Tension de sortie	100 / 110 / 115 / 120 VAC (± 5%) (sélection par interrupteurs DIP)		
	Rendement max.	92%	93%	94%
	Protection court-circuit	Temporisation d'une seconde		
	Signal de sortie ^②	Sinusoïdal pur (DHT < 5 %)		
Signal & contrôles	Commande déportée	CR-8 / CR-16 (en option)		
	Témoins	LEDs (rouge / orange / verte)		
	Borne à contact sec	Via un relais		
	Bornier de commande déportée	Bornier 6 broches vert (commandes Marche / Arrêt)		
Protections	Tension d'alimentation	Tension haute, tension basse, inversion de polarité (fusible interne)		
	Protections sortie CA	Court-circuit, surcharge		
	Autres protections	Température haute / basse (dissipateur + 80°C / - 20°C)		
Environnement	Plage admissible, température ambiante ^③	- 20 °C à + 40 °C		
	Plage admissible, température de stockage	- 30 °C à + 70 °C		
	Plage admissible, humidité de stockage	10 à 95 % (taux d'humidité relative)		
Normes	Sécurité	UL 458 (avec socle GFCI uniquement)		----
	CEM ^④	FCC classe A		
	E-mark	----		
Cotes (largeur x hauteur x profondeur)		248mm X 83mm X 443mm		
Poids		5.24 KG		
Refroidissement		Ventilateur asservi à la charge et à la température		
Relais de transfert		En option : TR-40		

Tableau 7 – modèles SP-2000 pour sorties 100 / 110 / 115 / 120 V CA



① Voir schéma 1

② Tension d'entrée : 12,5 V / 25 V / 50 V – Tension de sortie : 100 / 110 / 115 / 120 V CA
80 % de la puissance nominale (facteur de puissance = 1.0)

③ Voir schéma 2

④ **Attention** : appareil électrique de classe A. Dans un environnement sensible, cet appareil peut créer des interférences radio (prendre les mesures nécessaires).

		SP-2000-212	SP-2000-224	SP-2000-248
Entrée	Tension d'alimentation	12VDC	24VDC	48VDC
	Protection tension haute ^①	16,5 ± 0,3VDC	33 ± 0,5VDC	66 ± 1,0VDC
	Protection tension basse	10,5 ± 0,3VDC	21 ± 0,5VDC	42 ± 1,0VDC
	Plage de tensions admissibles	10,5 à 16,5VDC	21 à 33VDC	42 à 66VDC
	Courant à vide	≤ 1,8A @12VDC	≤ 1,0A @24VDC	≤ 0,5A @48VDC
	Consommation en Standby	<0,1A @12VDC	<0,05A @24VDC	<0,05A @48VDC
Sortie	Puissance nominale	2000 VA (± 3%)		
	Puissance nominale max. (1 min.)	> 2000 VA~2300 VA (100%~115%)		
	Puissance crête (max.3 s.)	< 3500 VA		
	Fréquence	50 / 60 Hz ± 0.5% (sélection par interrupteurs DIP)		
	Tension de sortie	200 / 220 / 230 / 240 VAC (± 3%) (sélection par interrupteurs DIP)		
	Rendement max.	94%	94%	95%
	Protection court-circuit	Temporisation d'une seconde		
	Signal de sortie ^②	Sinusoïdal pur (DHT < 3 %)		
Signal & contrôles	Commande déportée	CR-8 / CR-16 (en option)		
	Témoins	LEDs (rouge / orange / verte)		
	Borne à contact sec	Via un relais		
	Bornier de commande déportée	Bornier 6 broches vert (commandes Marche / Arrêt)		
Protections	Tension d'alimentation	Tension haute, tension basse, inversion de polarité (fusible interne)		
	Protections sortie CA	Court-circuit, surcharge		
	Autres protections	Température haute / basse (dissipateur + 80°C / - 20°C)		
Environnement	Plage admissible, température ambiante ^③	- 20 °C à + 40 °C		
	Plage admissible, température de stockage	- 30 °C à + 70 °C		
	Plage admissible, humidité de stockage	10 à 95 % (taux d'humidité relative)		
Normes	Sécurité	EN 60950-1		
	CEM ^④	EN 55022 class A; EN 55024; EN 61000-3-2, -3-3 EN 61000-4-2, 3, 4, 5, 6, 8, 11		
	E-mark	CISPR 25; ISO 7637-2		
Cotes (largeur x hauteur x profondeur)		248mm X 83mm X 443mm		
Poids		5.24 KG		
Refroidissement		Ventilateur asservi à la charge et à la température		
Relais de transfert		En option : TR-40		

Tableau 8 – modèles SP-2000 pour sorties 200 / 220 / 230 / 240 V CA



① Voir schéma 1

② Tension d'entrée : 12,5 V / 25 V / 50 V – Tension de sortie : 200 / 220 / 230 / 240 V CA
80 % de la puissance nominale (facteur de puissance = 1.0)

③ Voir schéma 2

④ **Attention** : appareil électrique de classe A. Dans un environnement sensible, cet appareil peut créer des interférences radio (prendre les mesures nécessaires).

2-3-5. SP-3000 Specification

		SP-3000-112	SP-3000-124	SP-3000-148
Entrée	Tension d'alimentation	12VDC	24VDC	48VDC
	Protection tension haute ^①	16,5 ± 0,3VDC	33 ± 0,5VDC	66 ± 1,0VDC
	Protection tension basse	10,5 ± 0,3VDC	21 ± 0,5VDC	42 ± 1,0VDC
	Plage de tensions admissibles	10,5 à 16,5VDC	21 à 33VDC	42 à 66VDC
	Courant à vide	≤ 3,8A @12VDC	≤ 2,0A @24VDC	≤ 1,0A @48VDC
	Consommation en Standby	<0,4A @12VDC	<0,2A @24VDC	<0,1A @48VDC
Sortie	Puissance nominale	3000 VA (± 3%)		
	Puissance nominale max. (1 min.)	> 3000 VA~3450 VA (100%~115%)		
	Puissance crête (1 s.)	< 6000 VA		
	Fréquence	50 / 60 Hz ± 0.5% (sélection par interrupteurs DIP)		
	Tension de sortie	100 / 110 / 115 / 120 VAC (± 5%) (sélection par interrupteurs DIP)		
	Rendement max.	90%	91%	92%
	Protection court-circuit	Temporisation d'une seconde		
Signal de sortie ^②	Sinusoidal pur (DHT < 5 %)			
Signal & contrôles	Commande déportée	CR-8 / CR-16 (en option)		
	Témoins	LEDs (rouge / orange / verte)		
	Borne à contact sec	Via un relais		
	Bornier de commande déportée	Bornier 6 broches vert (commandes Marche / Arrêt)		
Protections	Tension d'alimentation	Tension haute, tension basse, inversion de polarité (fusible interne)		
	Protections sortie CA	Court-circuit, surcharge		
	Autres protections	Température haute / basse (dissipateur + 80°C / - 20°C)		
Environnement	Plage admissible, température ambiante ^③	- 20 °C à + 40 °C		
	Plage admissible, température de stockage	- 30 °C à + 70 °C		
	Plage admissible, humidité de stockage	10 à 95 % (taux d'humidité relative)		
Normes	Sécurité	UL 458		----
	CEM ^④	FCC class A		
	E-mark	----		
Cotes (largeur x hauteur x profondeur)		255mm X 158mm X 442mm		
Poids		8.2 KG		
Refroidissement		Ventilateur asservi à la charge et à la température		
Relais de transfert		En option : TR-40		

Tableau 9 – modèles SP-3000 pour sorties 100 / 110 / 115 / 120 V CA



① Voir schéma 3

② Tension d'entrée : 12,5 V / 25 V / 50 V – Tension de sortie : 100 / 110 / 115 / 120 V CA
80 % de la puissance nominale (facteur de puissance = 1.0)

③ Voir schéma 4

④ **Attention** : appareil électrique de classe A. Dans un environnement sensible, cet appareil peut créer des interférences radio (prendre les mesures nécessaires).

		SP-3000-212	SP-3000-224	SP-3000-248
Entrée	Tension d'alimentation	12VDC	24VDC	48VDC
	Protection tension haute ^①	16,5 ± 0,3VDC	33 ± 0,5VDC	66 ± 1,0VDC
	Protection tension basse	10,5 ± 0,3VDC	21 ± 0,5VDC	42 ± 1,0VDC
	Plage de tensions admissibles	10,5 à 16,5VDC	21 à 33VDC	42 à 66VDC
	Courant à vide	≤ 3,8A @12VDC	≤ 2,0A @24VDC	≤ 1,0A @48VDC
	Consommation en Standby	<0,4A @12VDC	<0,2A @24VDC	<0,1A @48VDC
Sortie	Puissance nominale	3000 VA (± 3%)		
	Puissance nominale max. (1 min.)	> 3000 VA~3450 VA (100%~115%)		
	Puissance crête (1 s.)	< 6000 VA		
	Fréquence	50 / 60 Hz ± 0.5% (sélection par interrupteurs DIP)		
	Tension de sortie	200 / 220 / 230 / 240 VAC (± 3%) (sélection par interrupteurs DIP)		
	Rendement max.	90%	93%	94%
	Protection court-circuit	Temporisation d'une seconde		
Signal de sortie ^②	Sinusoïdal pur (DHT < 3 %)			
Signal & contrôles	Commande déportée	CR-8 / CR-16 (en option)		
	Témoins	LEDs (rouge / orange / verte)		
	Borne à contact sec	Via un relais		
	Bornier de commande déportée	Bornier 6 broches vert (commandes Marche / Arrêt)		
Protéctions	Tension d'alimentation	Tension haute, tension basse, inversion de polarité (fusible interne)		
	Protéctions sortie CA	Court-circuit, surcharge		
	Autres protections	Température haute / basse (dissipateur + 80°C / - 20°C)		
Environnement	Plage admissible, température ambiante ^③	- 20 °C à + 40 °C		
	Plage admissible, température de stockage	- 30 °C à + 70 °C		
	Plage admissible, humidité de stockage	10 à 95 % (taux d'humidité relative)		
Normes	Sécurité	EN 60950-1		
	CEM ^④	EN 55022 class A; EN 55024; EN 61000-3-2, -3-3 EN 61000-4-2, 3, 4, 5, 6, 8, 11		
	E-mark	CISPR 25; ISO 7637-2		
Cotes (largeur x hauteur x profondeur)		255mm X 158mm X 442mm		
Poids		8.2 KG		
Refroidissement		Ventilateur asservi à la charge et à la température		
Relais de transfert		En option : TR-40		

Tableau 10 – modèles SP-3000 pour sorties 200 / 220 / 230 / 240 V CA



① Voir schéma 3

② Tension d'entrée : 12,5 V / 25 V / 50 V – Tension de sortie : 200 / 220 / 230 / 240 V CA
80 % de la puissance nominale (facteur de puissance = 1.0)

③ Voir schéma 4

④ **Attention** : appareil électrique de classe A. Dans un environnement sensible, cet appareil peut créer des interférences radio (prendre les mesures nécessaires).

2-3-6. SP-4000 Specification

		SP-4000-124	SP-4000-148
Entrée	Tension d'alimentation	24VDC	48VDC
	Protection tension haute ^①	33 ± 0,5VDC	66 ± 1,0VDC
	Protection tension basse	21 ± 0,5VDC	42 ± 1,0VDC
	Plage de tensions admissibles	21 à 33VDC	42 à 66VDC
	Courant à vide	≤ 2,0A @24VDC	≤ 1,0A @48VDC
	Consommation en Standby	<0,2A @24VDC	<0,1A @48VDC
Sortie	Puissance nominale	4000 VA (± 3%)	
	Puissance nominale max. (1 min.)	> 4000 VA~4600 VA (100%~115%)	
	Puissance crête (1 s.)	< 8000 VA	
	Fréquence	50 / 60 Hz ± 0.5% (sélection par interrupteurs DIP)	
	Tension de sortie	100 / 110 / 115 / 120 VAC (± 5%) (sélection par interrupteurs DIP)	
	Rendement max.	91%	91%
	Protection court-circuit	Temporisation d'une seconde	
	Signal de sortie ^②	Sinusoïdal pur (DHT < 5 %)	
Signal & contrôles	Commande déportée	CR-8 / CR-16 (en option)	
	Témoins	LEDs (rouge / orange / verte)	
	Borne à contact sec	Via un relais	
	Bornier de commande déportée	Bornier 6 broches vert (commandes Marche / Arrêt)	
Protections	Tension d'alimentation	Tension haute, tension basse, inversion de polarité (fusible interne)	
	Protections sortie CA	Court-circuit, surcharge	
	Autres protections	Température haute / basse (dissipateur + 80°C / - 20°C)	
Environnement	Plage admissible, température ambiante ^③	- 20 °C à + 40 °C	
	Plage admissible, température de stockage	- 30 °C à + 70 °C	
	Plage admissible, humidité de stockage	10 à 95 % (taux d'humidité relative)	
Normes	Sécurité	Certified UL 458	----
	CEM ^④	Certified FCC class A	
	E-mark	----	
Cotes (largeur x hauteur x profondeur)		255mm X 158mm X 462mm	
Poids		10 KG	
Refroidissement		Ventilateur asservi à la charge et à la température	
Relais de transfert		En option : TR-40	

Tableau 11 – modèles SP-4000 pour sorties 100 / 110 / 115 / 120 V CA



① Voir schéma 3

② Tension d'entrée : 12,5 V / 25 V / 50 V – Tension de sortie : 100 / 110 / 115 / 120 V CA
80 % de la puissance nominale (facteur de puissance = 1.0)

③ Voir schéma 4

④ **Attention** : appareil électrique de classe A. Dans un environnement sensible, cet appareil peut créer des interférences radio (prendre les mesures nécessaires).

		SP-4000-224	SP-4000-248
Entrée	Tension d'alimentation	24VDC	48VDC
	Protection tension haute ^①	33 ± 0,5VDC	66 ± 1,0VDC
	Protection tension basse	21 ± 0,5VDC	42 ± 1,0VDC
	Plage de tensions admissibles	21 à 33VDC	42 à 66VDC
	Courant à vide	≤ 2,0A @24VDC	≤ 1,0A @48VDC
	Consommation en Standby	<0,2A @24VDC	<0,1A @48VDC
Sortie	Puissance nominale	4000 VA (± 3%)	
	Puissance nominale max. (1 min.)	> 4000 VA-4600 VA (100%~115%)	
	Puissance crête (1 s.)	< 8000 VA	
	Fréquence	50 / 60 Hz ± 0.5% (sélection par interrupteurs DIP)	
	Tension de sortie	200 / 220 / 230 / 240 VAC (± 3%) (sélection par interrupteurs DIP)	
	Rendement max.	90%	91%
	Protection court-circuit	Temporisations d'une seconde	
	Signal de sortie ^②	Sinusoïdal pur (DHT < 3 %)	
Signal & contrôles	Commande déportée	CR-8 / CR-16 (en option)	
	Témoins	LEDs (rouge / orange / verte)	
	Borne à contact sec	Via un relais	
	Bornier de commande déportée	Bornier 6 broches vert (commandes Marche / Arrêt)	
Protections	Tension d'alimentation	Tension haute, tension basse, inversion de polarité (fusible interne)	
	Protections sortie CA	Court-circuit, surcharge	
	Autres protections	Température haute / basse (dissipateur + 80°C / - 20°C)	
Environnement	Plage admissible, température ambiante ^③	- 20 °C à + 40 °C	
	Plage admissible, température de stockage	- 30 °C à + 70 °C	
	Plage admissible, humidité de stockage	10 à 95 % (taux d'humidité relative)	
Normes	Sécurité	EN 60950-1	
	CEM ^④	EN 55022 class A; EN 55024; EN 61000-3-2, -3-3; EN 61000-4-2, 3, 4, 5, 6, 8, 11	
	E-mark	CISPR 25; ISO 7637-2	
Cotes (largeur x hauteur x profondeur)		255mm X 158mm X 462mm	
Poids		10 KG	
Refroidissement		Ventilateur asservi à la charge et à la température	
Relais de transfert		En option : TR-40	

Tableau 12 – modèles SP-4000 pour sorties 200 / 220 / 230 / 240 V CA



① Voir schéma 3

② Tension d'entrée : 12,5 V / 25 V / 50 V – Tension de sortie : 200 / 220 / 230 / 240 V CA
80 % de la puissance nominale (facteur de puissance = 1.0)

③ Voir schéma 4

④ **Attention** : appareil électrique de classe A. Dans un environnement sensible, cet appareil peut créer des interférences radio (prendre les mesures nécessaires).

2-3-7. Schémas de performances



Schéma 1 – SP-700~SP-2000
Puissance en sortie / Tension
d'alimentation



Schéma 2 – SP-700~SP-2000
Puissance en sortie /
Température

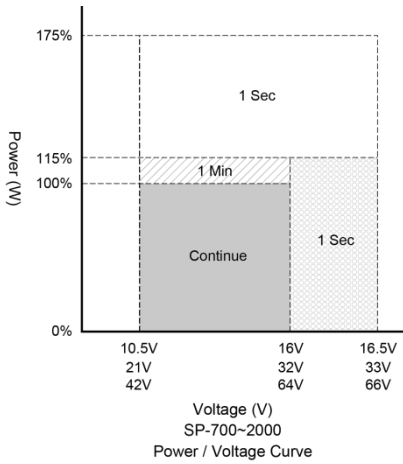

Schéma 3 – SP-3000~SP-4000
Puissance en sortie / Tension
d'alimentation

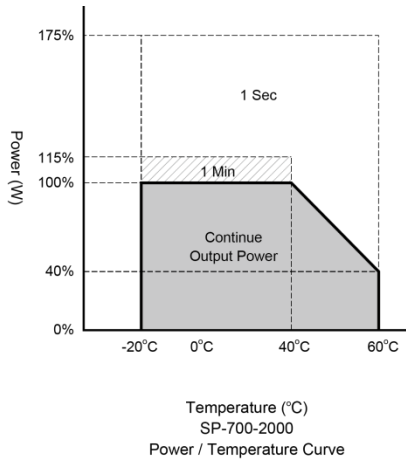

Schéma 4 – SP-3000~SP-4000
Puissance en sortie /
Température

2-4. Dessins techniques

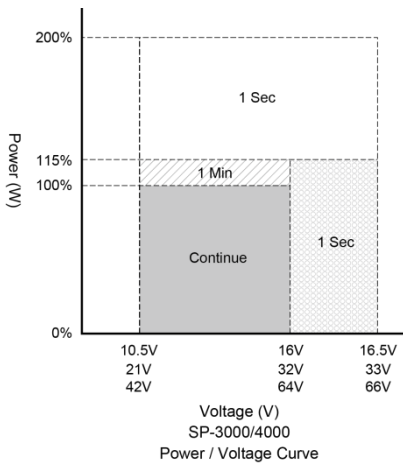

Schéma 5 – Onduleurs série SP (vue de dessus) SP-1500/2000/3000/4000

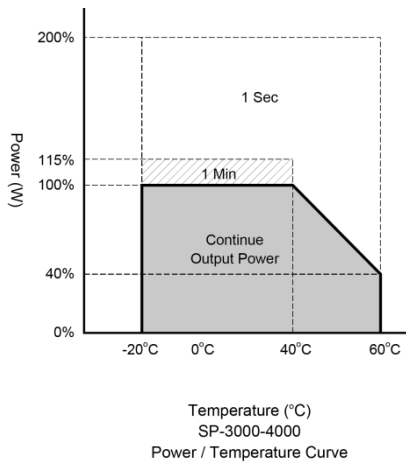

Schéma 6 – Onduleurs série SP (vue du panneau avant – sortie CA)

Modèle	A (mm)	B (mm)	C (mm)	D (mm)	E (mm)	F (mm)
SP-700	330	80	132	200	7.0	83
SP-1000	372	69	196	200	7.0	83
SP-1500	421	92	196	248	7.0	83
SP-2000	443	103	196	248	7.0	83
SP-3000	442	103	196	255	7.0	158
SP-4000	462	113	196	255	7.0	158

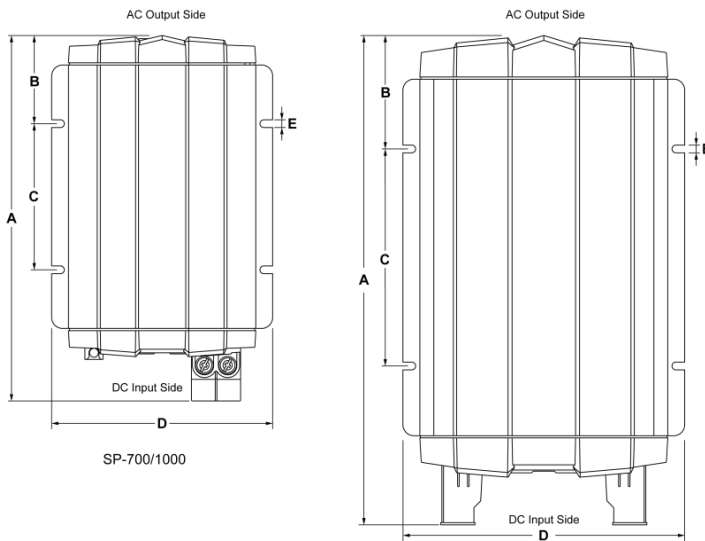
Tableau 13 – Cotes onduleurs série SP

3. Installation et maintenance

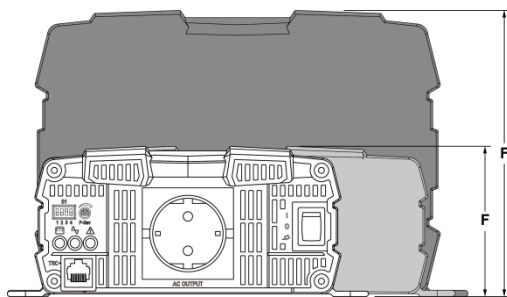
3-1. Présentation du panneau avant (côté sortie CA)



Schéma 7 – SP-700 / SP-1000 (côté sortie CA)



Schéma 8 – SP-1500 / SP-2000 (côté sortie CA)

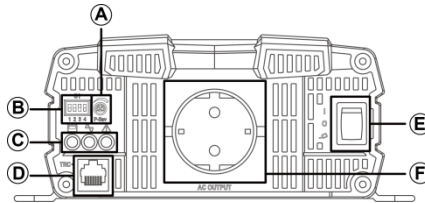

Schéma 9 – SP-3000 / SP-4000 (côté sortie CA)

Modèle	SP-700	SP-1000	SP-1500	SP-2000	SP-3000	SP-4000
Ⓐ	Réglage du mode Standby					
Ⓑ	Interrupteurs DIP					
Ⓒ	Indicateur à LEDs					
Ⓓ	Socle TRC (RJ45)					
Ⓔ	Interrupteur					
Ⓕ	Socle sortie CA				Borne sortie CA	

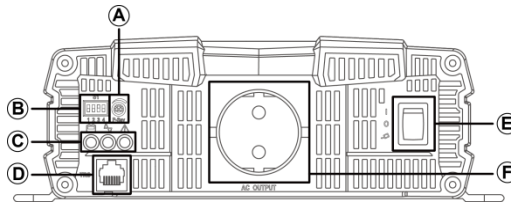
Tableau 14 – Présentation panneau avant (sortie CA) des onduleurs série SP

3-1-1. Interrupteur

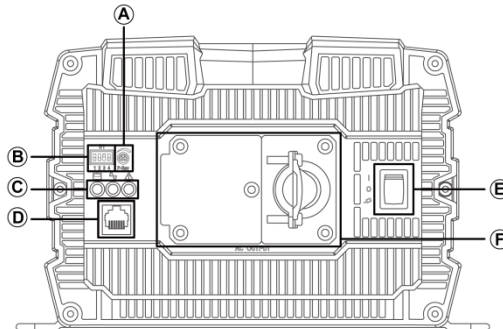
Il s'agit d'un interrupteur 3 positions (Marche / Arrêt / mode commande déportée). Repère (E) sur les schémas.

3-1-2. Indicateur à LEDs

3-1-2-1. Tension d'alimentation

LED tension d'entrée (C)	12V CC	24V CC	48V CC
Rouge	< 11,0V	< 22,0V	< 44,0V
Orange	11,0 ~ 11,5V	22,0 ~ 23,0V	44,0~46,0V
Verte	11,5 ~ 15,0V	23,0 ~ 30,0V	46,0~60,0V
Orange	15,0 ~ 15,5V	30,0 ~ 31,0V	60,0~62,0V
Rouge	>15,5V	>31,0V	>62,0V

Tableau 15 – Indicateurs niveau de tension d'alimentation

3-1-2-2. Tension de sortie CA (facteur de puissance = 1)

LED puissance de sortie (C)	Verte	Orange	Verte
SP-700	0 ~ 700 VA	700 ~ 805 VA	> 805 VA
SP-1000	0 ~ 1000 VA	1000 ~ 1150 VA	> 1150 VA
SP-1500	0 ~ 1500 VA	1500 ~ 1725 VA	> 1725 VA
SP-2000	0 ~ 2000 VA	2000 ~ 2300 VA	> 2300 VA
SP-3000	0 ~ 3000 VA	3000 ~ 3450 VA	> 3450 VA
SP-4000	0 ~ 4000 VA	4000 ~ 4600 VA	> 4600 VA

Tableau 16 – Indicateurs niveau de tension de sortie

3-1-2-3. État de l'onduleur

LED d'état (C)	État	Seuil de restauration
Verte	Normal	
Rouge	Protection sortie CA court-circuit ou surcharge	
Rouge, flashes lents	Protection tension basse (tension d'alimentation inférieure aux limites admissibles)	12,5V pour un système 12 V CC 25V pour un système 24 V CC 50V pour un système 48 V CC
Rouge, flashes rapides	Protection tension basse (tension d'alimentation inférieure aux limites admissibles)	14,5V pour un système 12 V CC 29V pour un système 24 V CC 58V pour un système 48 V CC
Orange	Échec au démarrage	—
Orange, flashes rapides	Protection température basse (température du dissipateur inférieure à -20°C)	> 0°C
Orange, flashes lents	Protection surchauffe (température du dissipateur supérieure à +80°C)	< 60°C (température du dissipateur)

Tableau 17 – Indicateurs d'état de l'onduleur

3-1-3. Introduction aux interrupteurs DIP



Schéma 10 – Interrupteurs DIP

3-1-3-1. Fonctions des interrupteurs DIP

Interrupteur DIP (B)	Fonction
S1	Sélection de la tension de sortie
S2	Sélection de la tension de sortie
S3	Sélection de la fréquence
S4	Paramétrage du mode Standby (activé / désactivé)

Tableau 18 – Fonctions des interrupteurs DIP

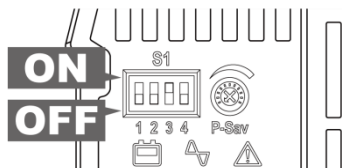
3-1-3-2. Sélection de la tension de sortie (S1 & S2)

Tension de sortie	S1	S2
100V/200V	OFF	OFF
110V/220V	ON	OFF
115V/230V	OFF	ON
120V/240V	ON	ON

Tableau 19 – Sélection de la tension de sortie



NB :

Choix possibles pour les modèles 100 V : 100 / 110 / 115 / 120 V CA.

Choix possibles pour les modèles 200 V : 200 / 220 / 230 / 240 V CA.

3-1-3-3. Sélection de la fréquence (S3)

Fréquence	S3
50Hz	OFF
60Hz	ON

Tableau 20 – Sélection de la fréquence

3-1-3-4. Paramétrage du mode Standby (S4)

État	S4
Standby désactivé	OFF
Standby activé	ON

Tableau 21 – Paramétrage du mode Standby

3-1-3-5. Étalonnage du mode Standby

L'utilisateur peut utiliser le potentiomètre pour définir les seuils mini et maxi du mode Standby en fonction de la demande, dans les limites indiquées ci-dessous.

Ⓐ	Seuil d'entrée Standby (minimum)	Seuil de sortie Standby (minimum)
SP-700	<20 VA	>40 VA
SP-1000	<20 VA	>40 VA
SP-1500	<20 VA	>40 VA
SP-2000	<20 VA	>40 VA
SP-3000	<40 VA	>60 VA
SP-4000	<40 VA	>60 VA

Tableau 22 – Limites admissibles des seuils mini

Ⓐ	Seuil d'entrée Standby (maximum)	Seuil de sortie Standby (maximum)
SP-700	<110 VA	>160 VA
SP-1000	<110 VA	>160 VA
SP-1500	<110 VA	>160 VA
SP-2000	<110 VA	>160 VA
SP-3000	<240 VA	>280 VA
SP-4000	<240 VA	>280 VA

Tableau 23 – Limites admissibles des seuils maxi

3-1-4. Socle relais de transfert TRC (pour kits TR-40, RJ-45 en option)

Broche	Description du signal	
1	Réservé	--
2	PH-L	Passage par zéro
3	PH-N	Passage par zéro
4	Bypass	Signal de transfert
5	12V	Alimentation interne contrôleur TR-40
6	5V	Alimentation interne contrôleur TR-40
7	Masse (GND)	Négatif
8	Réservé	--

Tableau 24 – Kit RJ-45



Schéma 11 – Connexions onduleur SP / TR-40

**NB :**

pour plus de détails, se reporter au manuel du TR-40.

3-1-5. Interfaces de sortie CA

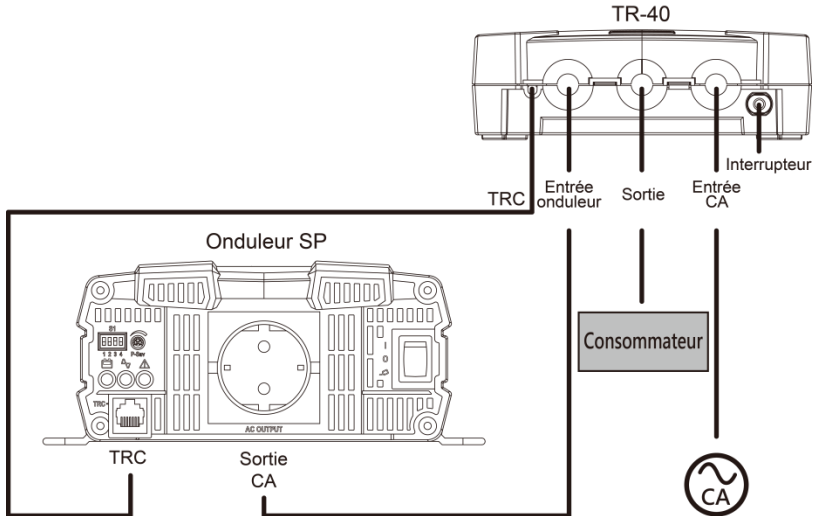
3-1-5-1. Socles CA sur onduleurs SP

Type de socle (F)	Disponible sur modèles
 <p>USA(GFCI) NEMA 5-15R</p>	SP-700/1000-112/124/148
 <p>USA(GFCI) NEMA 5-20R</p>	SP-1500/2000-112/124/148
 <p>Australie / Nlle-Zélande Europe continentale GB</p>	SP-700/1000/1500/2000/3000- 212/224/248
 <p>Universelle</p>	SP-700/1000/1500/2000-112/124/148 SP-700/1000/1500/2000/3000- 212/224/248
 <p>Bornier</p>	SP-3000-112/124/148/212/224/248 SP-4000-124/148/224/248
 <p>France</p>	SP-700/1000/1500/2000/3000- 212/224/248

Tableau 25 – Socles CA disponibles en fonction des modèles

3-1-5-2. Bornier de sortie CA sur modèles SP-3000 / 40000

Bornier de sortie CA (F)		Couleur	Section
Bornes CA	Phase – L	Noir	Jusqu'à 5 m (16 ft) 200-240 V CA : 6 mm ² (10 AWG) 100-120 V CA : 10 mm ² (8 AWG)
	Neutre – N	Blanc	
Masse – FG		Vert /Jaune ou cuivre dénudé	Entre 8 & 10 m (26-32 ft) 6 mm ² à 10 mm ² (10-8 AWG)

Tableau 26 – Bornier CA sur modèles SP-3000 et SP-4000

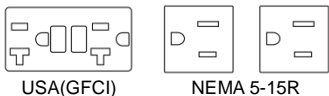
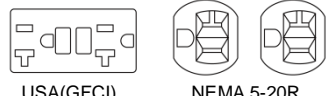
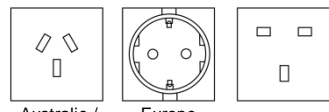
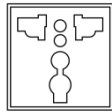
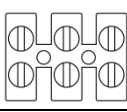
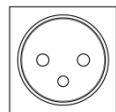
3-1-5-3. Socle GFCI

Modèles recommandés :

- Hubbel : type GF20 et GFRST20 – 125 V, 20 A
- Cooper : type VGF20 et SGF20 – 125 V, 20 A
- Leviton : type 7899-W et GFNT2 – 125 V, 20 A
- PASS & SEYMOUR INC, Type 2097 – 125V, 20A

3-2. Présentation du panneau arrière (côté entrée CC)



Schéma 12 - SP-700 / 1000 (côté entrée CC)



Schéma 13 - SP-1500 / 2000 (côté entrée CC)

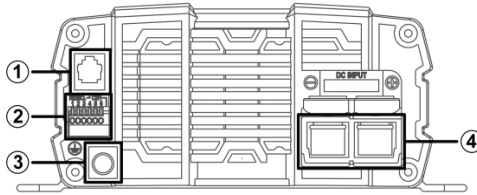

Schéma 14 - SP-3000 / 4000 (côté entrée CC)

Modèle	SP-700	SP-1000	SP-1500	SP-2000	SP-3000	SP-4000
①	Socle (RJ11)					
②	Bornier commande déportée, vert					
③	Borne de liaison à la masse					
④	Socle entrée CC					

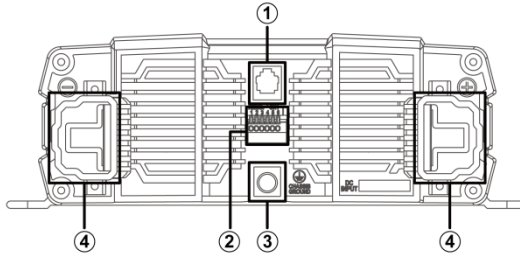
Tableau 27 – Présentation du panneau arrière (côté entrée CC)

3-2-1. Socle RJ-11

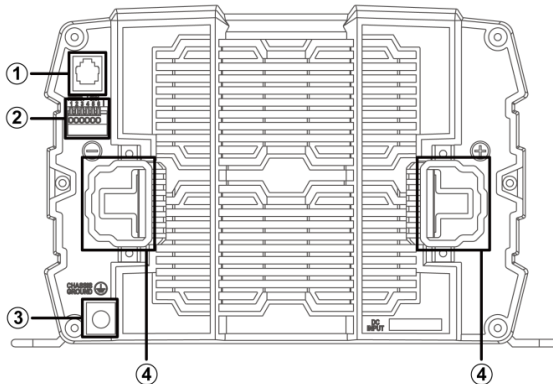
Les onduleurs de la série SP sont compatibles avec les commandes CR-8 et CR-16, via un port de communication RS-232.

Avant d'utiliser une commande déportée, s'assurer que l'interrupteur sur l'onduleur soit bien en position « Mode commande déportée » (REMOTE).

Broche	Description du signal ①	
1	Réservé	--
2	Masse – GND	Négatif
3	RXD	RS232 RXD (Réception de données)
4	TXD	RS232 TXD (Transmission de données)
5	RMT	Panneau commande déportée (positif)
6	VCC	Alimentation interne commande déportée

Tableau 28 – Kit TR-40

3-2-2. Bornier de la commande déportée (bornier vert)

Le bornier vert ② de la commande déportée peut être connecté à un relais de forme C pour qu'en cas de défaut, le relais commute.



Schéma 15 – Bornier de la commande déportée

Borne	Description	Borne	Description
1	Contact sec (NO)	4	Enable+ (ENB)
2	Commun	5	Enable- (ĒNB)
3	Contact sec (NF)	6	Masse (GND)

Tableau 29 – Relais à contact sec

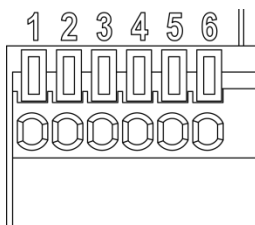

NB : la borne 6 a la même polarité que la borne négative de la batterie.



NB : défauts possibles : tension d'alimentation basse / haute, court-circuit (sortie CA), surcharge, température haute / basse.



Attention : merci de respecter les instructions suivantes pour l'installation.

- S'assurer que l'interrupteur est en position « Arrêt » (OFF), avant d'installer l'onduleur.
- Avant d'utiliser la commande déportée, s'assurer que l'interrupteur est en position « Commande déportée » (REMOTE).
- Utiliser du câble d'une section de 0,5 mm² - 0,25 mm² (20-24 AWG) pour les branchements.



Schéma 16 – Configurations possibles de l'interrupteur déporté

3-2-3. Consignes générales – Entrée CC ④

Les câbles doivent être le plus court possible, idéalement d'une longueur inférieure à 1,8 m (6 ft).

La section doit être suffisante pour que les chutes de tension soient inférieures à 2%, afin d'éviter les alarmes tension basse voire l'arrêt de l'onduleur.

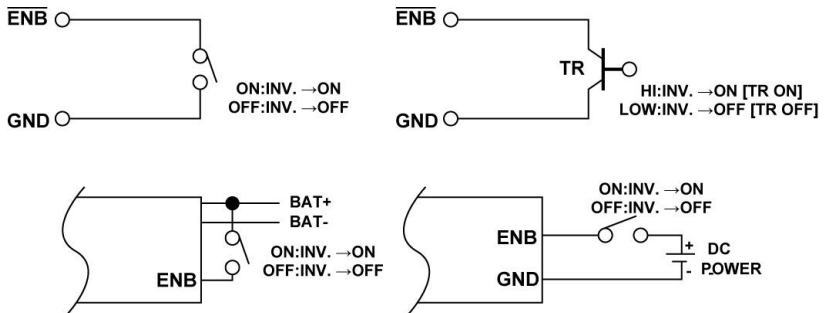
Se reporter au tableau suivant pour le dimensionnement des câbles et du fusible (dimensionnements recommandés pour une distance jusqu'à 1,8 m (6 ft).

Modèle	Section des câbles	Calibre du fusible
SP-700-112 / 212	16 mm ² (6 AWG)	≥ 150A
SP-700-124 / 224	6 mm ² (10 AWG)	≥ 80 A
SP-700-148 / 248	1,5 mm ² (16 AWG)	≥ 50 A
SP-1000-112 / 212	25 mm ² (4 AWG)	≥ 225A
SP-1000-124 / 224	10 mm ² (8 AWG)	≥ 125A
SP-1000-148 / 248	2,5 mm ² (14 AWG)	≥ 80A
SP-1500-112 / 212	35 mm ² (1 AWG)	≥ 350A
SP-1500-124 / 224	16 mm ² (6 AWG)	≥ 175A
SP-1500-148 / 248	6 mm ² (10 AWG)	≥ 90A
SP-2000-112 / 212	50 mm ² (1/0 AWG)	≥ 500A
SP-2000-124 / 224	25 mm ² (4 AWG)	≥ 225A
SP-2000-148 / 248	10 mm ² (8 AWG)	≥ 150A
SP-3000-112 / 212	95 mm ² (4/0 AWG)	≥ 700A
SP-3000-124 / 224	35 mm ² (1 AWG)	≥ 350A
SP-3000-148 / 248	16 mm ² (6 AWG)	≥ 175A
SP-4000-124 / 224	50 mm ² (1/0 AWG)	≥ 500A
SP-4000-148 / 248	25 mm ² (4 AWG)	≥ 275A

Tableau 30 – Dimensionnement câbles et fusible en ligne



NB : les batteries peuvent délivrer des courants très forts en cas de court-circuit. Le fusible doit être monté le plus près possible de la borne positive de la batterie. Utiliser un fusible type Bussmann ANN avec porte-fusible type 4164 ou équivalent.

3-2-4. Liaison à la masse ③

Commencer par effectuer la liaison à la masse avant tout autre branchement.

3-3. Entretien

S'assurer que les grilles de ventilations ne soient pas obstruées.

Utiliser un aspirateur pour enlever la poussière autour du ventilateur.

Utiliser un chiffon propre et sec pour nettoyer le boîtier et le panneau avant de l'onduleur. S'il est vraiment encrassé, utiliser un détergent doux et non abrasif. Ne jamais utiliser de produits de nettoyage à base d'alcool ou d'ammoniac.

L'entretien ou le déplacement de l'onduleur doit être effectué par un technicien qualifié. Prendre soin de ne pas répandre de liquides sur l'onduleur.

4. Utilisation de l'onduleur

4-1. Bornes d'entrée courant continu

Raccorder les bornes d'entrée courant continu à une batterie 12 V, 24 V ou 48 V ou à une source équivalente.

[+] représente la borne positive, [-] la borne négative. Une inversion des pôles peut faire fondre le fusible interne et endommager irrémédiablement l'onduleur.



Schéma 17 - Entrée courant continu



Attention! prendre soin de serrer correctement les connexions (11,7 à 13 Nm – 9 - 10 lbs). Des connexions mal serrées peuvent entraîner une surchauffe potentiellement dangereuse.



Attention! le fusible (conforme aux prescriptions du tableau 30) doit être monté le plus près possible de la borne positive (+) de la batterie. Ne pas installer ce fusible entre l'onduleur et la batterie peut provoquer des dommages (câble / onduleur) et entraînera l'annulation de la garantie.

Utiliser exclusivement des câbles cuivre de qualité.

La longueur des câbles doit être comprise entre 0,91 et 1,82 m maximum (3-6 ft).



Schéma 18 – Connexion batterie-onduleur

4-2. Connexions courant continu

S'assurer que l'interrupteur sur l'onduleur (E) est bien en position « Arrêt » (OFF) avant de raccorder l'entrée courant continu (4).

4-3. Connexions courant alternatif (consommateurs)

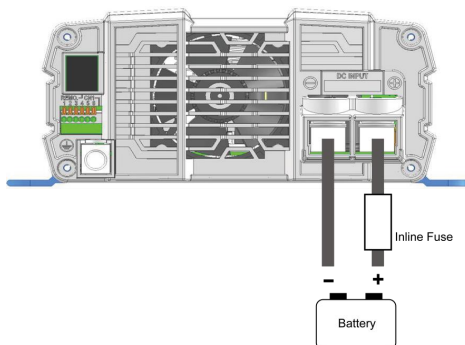
Calculer la charge totale et s'assurer qu'elle ne dépasse pas la puissance nominale de l'onduleur.

Si tel est le cas, débrancher les consommateurs non essentiels jusqu'à ce que la charge totale soit inférieure à la puissance nominale de l'onduleur.

4-4. Marche / Arrêt de l'onduleur

Placer l'interrupteur (E) sur « Marche » (ON). Durant la phase d'auto-test, les LEDs s'allument de différentes couleurs.

Placer l'interrupteur (E) sur « Arrêt » (OFF). L'onduleur s'arrête et toutes les LEDs s'éteignent.

4-5. Protections

Modèle	Surtension (CC)		Alarme tension basse	Tension basse	
	Coupure	Reprise		Coupure	Reprise
12V	16,5V ± 0,3V	14,5V ± 0,3V	10,5V ± 0,3V	10,5V ± 0,3V	12,5V ± 0,3V
24V	33V ± 0,5V	29V ± 0,5V	21V ± 0,5V	21V ± 0,5V	25V ± 0,5V
48V	66 ± 1V	58V ± 1V	42V ± 1V	42V ± 1V	50 ± 1V

Tableau 31 – Protections

Modèle	Protection surchauffe	
	Coupure	Reprise
12V	80°C	60°C
24V		
48V		

Tableau 32 – Protection surchauffe

5. Port de communication RS-232

5-1. Caractéristiques

Le RS-232 est un port série permettant de contrôler l'onduleur via un ordinateur.



Schéma 19 – Câble RS-232

Onduleur SP		Ordinateur	
Broche	Description	Broche	Description
1	Non utilisée	1	Non utilisée
2	Masse (GND)	2	RXD (réception données)
3	RXD (réception données)	3	TXD (transmission données)
4	TXD (transmission données)	4	Non utilisée
5	Commande déportée (Remote)	5	Masse (GND)
6	Tension CC	6	Non utilisée
		7	Non utilisée
		8	Non utilisée
		9	Non utilisée

Tableau 33 – Connecteurs RS-232

5-2. Procédure d'utilisation

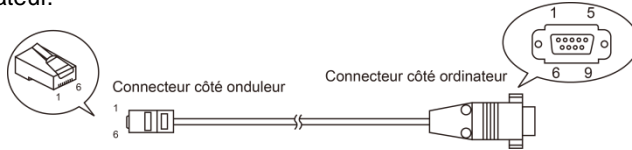
- Étape 1 Raccorder le l'onduleur à l'ordinateur via le port RS-232 sur le panneau avant.
- Étape 2 Lancer le programme de communication sur l'ordinateur.
- Étape 3 Choisir le protocole de transmission des données :
Format : Bit de départ – 8 bits de données – Bit d'arrêt
Débit : 4 800 bauds
- Étape 4 Choisir un port de communication (COM) et lancer l'opération

5-3. Mode de fonctionnement du port RS-232

5-3-1. Format des commandes RS-232

Cet appareil utilise un langage de haut niveau :
chaque commande débute par CR (0DH) et se termine par LF (0AH).
Le système ne peut interpréter et exécuter la commande qu'après réception de ces 2 derniers caractères.

Une fois la commande exécutée le système envoie une réponse de ce type :

- => CR LF: Commande exécutée avec succès
- ?> CR LF: Erreur, commande non acceptée
- !> CR LF: Commande correcte mais erreur d'exécution
(exemple : paramètres hors limites admissibles)

5-3-2. Commandes utiles

Les tableaux suivants indiquent les paramètres par défaut des fonctions (FUNC) mentionnées ci-dessus.

Fonction	Commande et description																						
Marche/Arrêt de l'onduleur (ON/OFF)	Power <value> « 0 » : OFF « 1 » ON																						
Demander la fréquence	FRQ?																						
Demander la tension de sortie	VINV?																						
Demander le courant de sortie	IINV?																						
Rechercher les codes défaut	ERR? (SP-700~2000)																						
	<table border="1"> <thead> <tr> <th>Bit</th> <th>Description</th> </tr> </thead> <tbody> <tr> <td>BIT0</td> <td>0: No OLPL Protection 1: OLPL Protection</td> </tr> <tr> <td>BIT1</td> <td>0:No Sof Fail Protection 1:SofFail Protection</td> </tr> <tr> <td>BIT2</td> <td>0:No Poff Protection 1:Poff Protection</td> </tr> <tr> <td>BIT3</td> <td>0:No UVP Protection 1:UVP Protection</td> </tr> <tr> <td>BIT4</td> <td>0:No OVP Protection 1:OVP Protection</td> </tr> <tr> <td>BIT5</td> <td>0:No OLPM Protection 1: OLPM Protection</td> </tr> <tr> <td>BIT6</td> <td>0:No OLPH Protection 1: OLPH Protection</td> </tr> <tr> <td>BIT7</td> <td>0:No OTP Protection 1: OTP Protection</td> </tr> <tr> <td>BIT8</td> <td>0:No UTP Protection 1: UTP Protection</td> </tr> <tr> <td>BIT9</td> <td>0:No OOC Protection 1: OOC Protection</td> </tr> </tbody> </table>	Bit	Description	BIT0	0: No OLPL Protection 1: OLPL Protection	BIT1	0:No Sof Fail Protection 1:SofFail Protection	BIT2	0:No Poff Protection 1:Poff Protection	BIT3	0:No UVP Protection 1:UVP Protection	BIT4	0:No OVP Protection 1:OVP Protection	BIT5	0:No OLPM Protection 1: OLPM Protection	BIT6	0:No OLPH Protection 1: OLPH Protection	BIT7	0:No OTP Protection 1: OTP Protection	BIT8	0:No UTP Protection 1: UTP Protection	BIT9	0:No OOC Protection 1: OOC Protection
	Bit	Description																					
	BIT0	0: No OLPL Protection 1: OLPL Protection																					
	BIT1	0:No Sof Fail Protection 1:SofFail Protection																					
	BIT2	0:No Poff Protection 1:Poff Protection																					
	BIT3	0:No UVP Protection 1:UVP Protection																					
	BIT4	0:No OVP Protection 1:OVP Protection																					
	BIT5	0:No OLPM Protection 1: OLPM Protection																					
	BIT6	0:No OLPH Protection 1: OLPH Protection																					
	BIT7	0:No OTP Protection 1: OTP Protection																					
	BIT8	0:No UTP Protection 1: UTP Protection																					
BIT9	0:No OOC Protection 1: OOC Protection																						
* Voir tableau 35 pour la description des protections.																							

Fonction	Commande et description																										
	ERR? (SP-3000~4000) <table border="1"> <thead> <tr> <th> Bit </th> <th> Description </th> </tr> </thead> <tbody> <tr> <td> BIT0 </td> <td> 0: No ID Fail 1: ID Fail </td> </tr> <tr> <td> BIT1 </td> <td> 0:No Sof Fail Protection 1:SofFail Protection </td> </tr> <tr> <td> BIT2 </td> <td> 0:No PLL Fail 1:PLL Fail </td> </tr> <tr> <td> BIT3 </td> <td> 0:No Poff Protection 1:Poff Protection </td> </tr> <tr> <td> BIT4 </td> <td> 0:No Short Protection 1:Short Protection </td> </tr> <tr> <td> BIT5 </td> <td> 0:No OOC Protection 1: OOC Protection </td> </tr> <tr> <td> BIT6 </td> <td> 0:NoOVP Protection 1:OVP Protection </td> </tr> <tr> <td> BIT7 </td> <td> 0:No UVP Protection 1:UVP Protection </td> </tr> <tr> <td> BIT8 </td> <td> 0:No OTP Protection 1: OTP Protection </td> </tr> <tr> <td> BIT9 </td> <td> 0:No UTP Protection 1: UTP Protection </td> </tr> <tr> <td> BIT10 </td> <td> 0:No OLP Protection 1: OLP Protection </td> </tr> <tr> <td> BIT11 </td> <td> 0:No OLPL Protection 1: OLPL Protection </td> </tr> </tbody> </table> <p>* Voir tableau 36 pour la description des protections.</p>	Bit	Description	BIT0	0: No ID Fail 1: ID Fail	BIT1	0:No Sof Fail Protection 1:SofFail Protection	BIT2	0:No PLL Fail 1:PLL Fail	BIT3	0:No Poff Protection 1:Poff Protection	BIT4	0:No Short Protection 1:Short Protection	BIT5	0:No OOC Protection 1: OOC Protection	BIT6	0:NoOVP Protection 1:OVP Protection	BIT7	0:No UVP Protection 1:UVP Protection	BIT8	0:No OTP Protection 1: OTP Protection	BIT9	0:No UTP Protection 1: UTP Protection	BIT10	0:No OLP Protection 1: OLP Protection	BIT11	0:No OLPL Protection 1: OLPL Protection
Bit	Description																										
BIT0	0: No ID Fail 1: ID Fail																										
BIT1	0:No Sof Fail Protection 1:SofFail Protection																										
BIT2	0:No PLL Fail 1:PLL Fail																										
BIT3	0:No Poff Protection 1:Poff Protection																										
BIT4	0:No Short Protection 1:Short Protection																										
BIT5	0:No OOC Protection 1: OOC Protection																										
BIT6	0:NoOVP Protection 1:OVP Protection																										
BIT7	0:No UVP Protection 1:UVP Protection																										
BIT8	0:No OTP Protection 1: OTP Protection																										
BIT9	0:No UTP Protection 1: UTP Protection																										
BIT10	0:No OLP Protection 1: OLP Protection																										
BIT11	0:No OLPL Protection 1: OLPL Protection																										
Demander la tension batterie (CC)	VBAT?																										
Demander la puissance de sortie	PINV?																										
Réinitialiser un défaut	*RST																										
Sélectionner un paramètre via le code de la fonction	FUNC <Function Code> <table border="1"> <thead> <tr> <th> Function code </th> <th> Setting Menu </th> </tr> </thead> <tbody> <tr> <td> 0 </td> <td> OVP setting </td> </tr> <tr> <td> 1 </td> <td> OVP Recovery </td> </tr> <tr> <td> 2 </td> <td> UVP Setting </td> </tr> <tr> <td> 3 </td> <td> UVP Recovery </td> </tr> <tr> <td> 5 </td> <td> RS-232 Baud-rate </td> </tr> <tr> <td> 6 </td> <td> Retry Time </td> </tr> </tbody> </table>	Function code	Setting Menu	0	OVP setting	1	OVP Recovery	2	UVP Setting	3	UVP Recovery	5	RS-232 Baud-rate	6	Retry Time												
Function code	Setting Menu																										
0	OVP setting																										
1	OVP Recovery																										
2	UVP Setting																										
3	UVP Recovery																										
5	RS-232 Baud-rate																										
6	Retry Time																										
Obtenir le n° d'une fonction	FUNC?																										
Obtenir le paramètre d'une fonction	SETT?																										
Définir/modifier la valeur d'un paramètre	SETT <value>																										

Tableau 34 – Commandes RS-232

SP-700 ~ SP-2000 Protections

Protection	Description
OLPL Protection	OLPL: Protection surcharge, seuil bas (101~115%)
Sof Fail Protection	Sof Fail: Échec démarrage progressif
Poff Protection	Poff: Protection rupture d'alimentation
UVP Protection	UVP: Protection tension basse
OVP Protection	OVP: Protection surtension
OLPM Protection	OLPM: Protection surcharge, seuil intermédiaire (116~200%)
OLPH Protection	OLPH: Protection surcharge, seuil haut (>200%)
OTP Protection	OTP: Protection surchauffe
UTP Protection	UTP: Protection température basse
OOC Protection	OOC: Protection surintensité, sortie

Tableau 35. SP-700 ~ SP-2000 Protections & défauts

SP-3000 ~ SP-4000 Protections & défauts

Protection	Description
ID	ID: Erreur connexion
Sof Fail Protection	Sof Fail: Échec démarrage progressif
PLL	PLL: Boucle à verrouillage de phase
Poff Protection	Poff: Protection rupture d'alimentation
OOC Protection	OOC: Protection surintensité, sortie (Surcharge > 200%)
OVP Protection	OVP: Protection surtension
UVP Protection	UVP: Protection tension basse
OTP Protection	OTP: Protection surchauffe
UTP Protection	UTP: Protection température basse
OLPH Protection	OLPH: Protection surcharge, seuil haut (116~200%)
OLPL Protection	OLPL: Protection surcharge, seuil bas (101~115%)

Tableau 36. SP-3000 ~ SP-4000 Protections & défauts



Note: pour les fonctions suivantes; les valeurs par défaut sont restaurées chaque fois que l'onduleur est éteint puis rallumé.

5-3-2-1. FUNC 0 – OVP Setting – Coupure tension haute

SETT <value>	Default	Model
15.0 ~ 16.5	16.5V <16.5>	SP series-112 / 212
30.0 ~ 33.0	33.0V <33.0>	SP series-124 / 224
60.0 ~ 66.0	66.0V <66.0>	SP series-148 / 248

Tableau 37 – Valeur par défaut coupure OVP

5-3-2-2. FUNC 1 – OVP Recovery – Reprise tension haute

SETT <value>	Default	Model
13.5 ~ 14.5	14.5V <14.5>	SP series-112 / 212
27.0 ~ 29.0	29.0V <29.0>	SP series-124 / 224
54.0 ~ 58.0	58.0V <58.0>	SP series-148 / 248

Tableau 38 – Valeur par défaut reprise OVP

5-3-2-3. FUNC 2 – UVP Setting – Coupure tension basse

SETT <value>	Default	Model
10.5 ~ 11.5	10.5V <10.5>	SP series-112 / 212
21.0 ~ 23.0	21.0V <21.0>	SP series-124 / 224
42.0 ~ 46.0	42.0V <42.0>	SP series-148 / 248

Tableau 39 – Valeur par défaut coupure UVP

5-3-2-4. FUNC 3 – UVP Setting – Reprise tension basse

SETT <value>	Default	Model
12.5 ~ 13.5	12.5V <12.5>	SP series-112 / 212
25.0 ~ 27.0	25.0V <25.0>	SP series-124 / 224
50.0 ~ 54.0	50.0V <50.0>	SP series-148 / 248

Tableau 40 – Valeur par défaut reprise UVP

5-3-2-5. FUNC 5 – RS-232 Baud Rate – Débit port communication RS-232

SETT <value>	Default	Model
0	2	1200
1		2400
2		4800
3		9600

Tableau 41 – Valeur par défaut Baud Rate

5-3-2-6. FUNC 6 – Retry Time – Délai avant ré-essai

SETT <value>	Default
0	3
1	
2	
3	

Tableau 42 – Valeur par défaut Retry Time

6. Garantie

6-1. Avertissement



Attention! ne pas ouvrir ni démonter l'onduleur. Risques de chocs électriques ou d'incendie.

6-2. Garantie

Nous garantissons que ce produit est exempt de défauts de matériel ou de main-d'oeuvre pour une durée de 24 mois à compter de la date d'achat. Merci de contacter votre revendeur pour les interventions de maintenance ou les demandes en garantie.

Cette garantie est considérée comme nulle en cas d'utilisation abusive, de modification ou de dommages par accident. COTEK ne saurait être tenu pour responsable d'aucun événement survenant suite à une faute de l'utilisateur.

COTEK

No.33, Sec. 2, Renhe Rd., Daxi Dist., Taoyuan City 33548, Taiwan

Phone : +886-3-3891999 FAX : +886-3-3802333

[http : // www.cotek.com.tw](http://www.cotek.com.tw)

2017.10._A1